



-master-

INTERIOR

INTERIOR

2 BAY

- 01 평면도
- 02 천정도(A/B TYPE)
- 03 파사드
- 04 작업장입면도

3 BAY

- 01 평면도
- 02 천정도(A/B TYPE)
- 03 장비도
- 04 에어/오일 배관도
- 03 파사드
- 04 작업장입면도
- 05 사무실입면도
- 05 작업장 투시도
- 06 사무실 투시도
- 07 파사드 투시도 (주간/야간)

4 BAY

- 01 평면도
- 02 천정도(A/B TYPE)
- 03 파사드
- 04 작업장입면도

공사상세도

- 01 작업장 공구걸이
- 02 어닝(A,B,C,D TYPE)
- 03 "M"-LINE 현수막 걸이

FURNITURE

- 01 작업장 타이어랙(1단)
- 02 작업장 타이어랙(2단)
- 03 작업장 타이어랙(3단)
- 04 작업장 UNIT장
- 05 사무실 이미지월
- 06 작업장내 사인
- 07 카운터
- 08 프린터용책상
- 09 대기테이블
- 10 하부장
- 11 기성가구(원형테이블+의자)

MATERIALS



2 BAY

2 BAY FLOOR PLAN

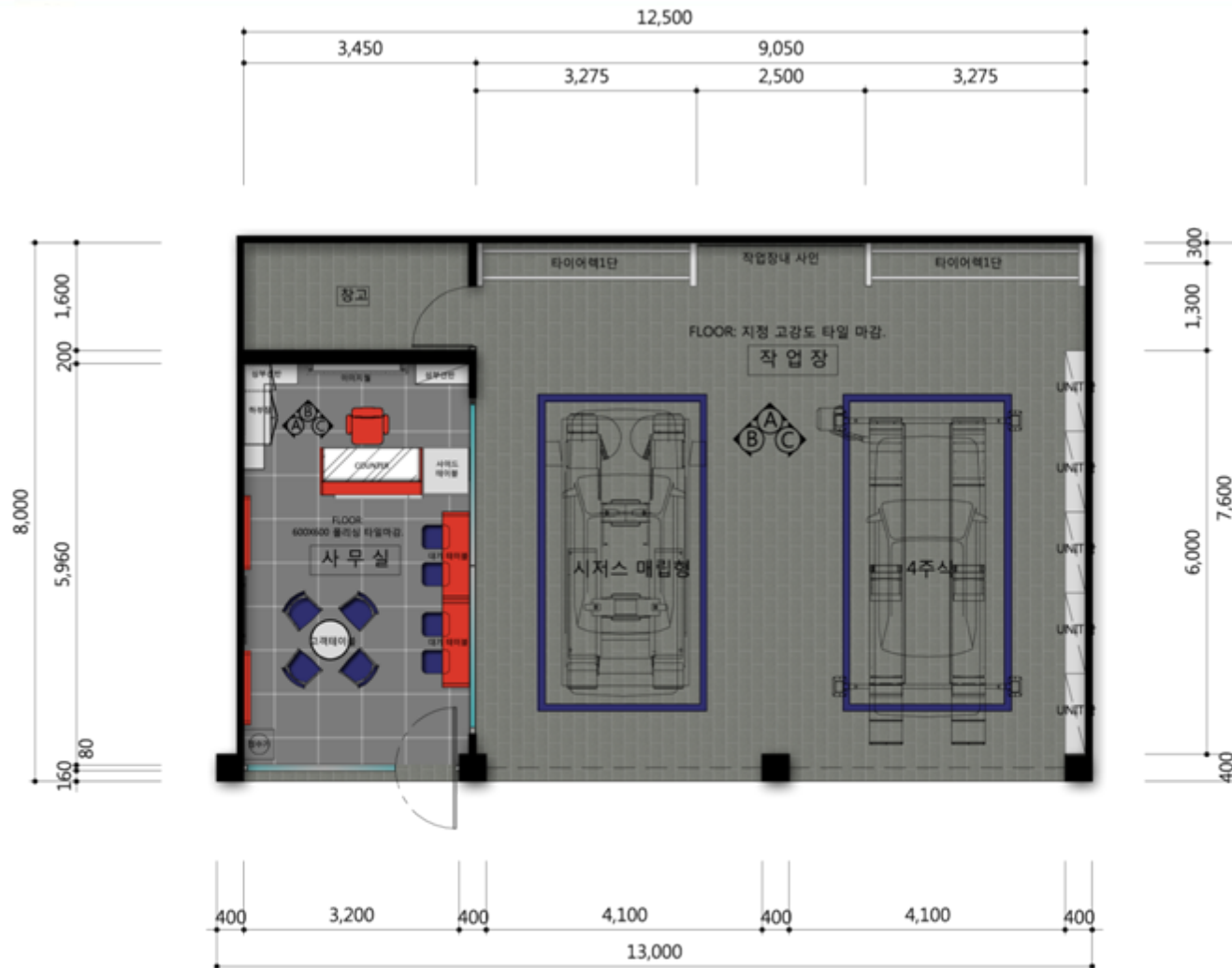

FLOOR PLAN
SCALE 1/80

2 BAY CEILING PLAN-A

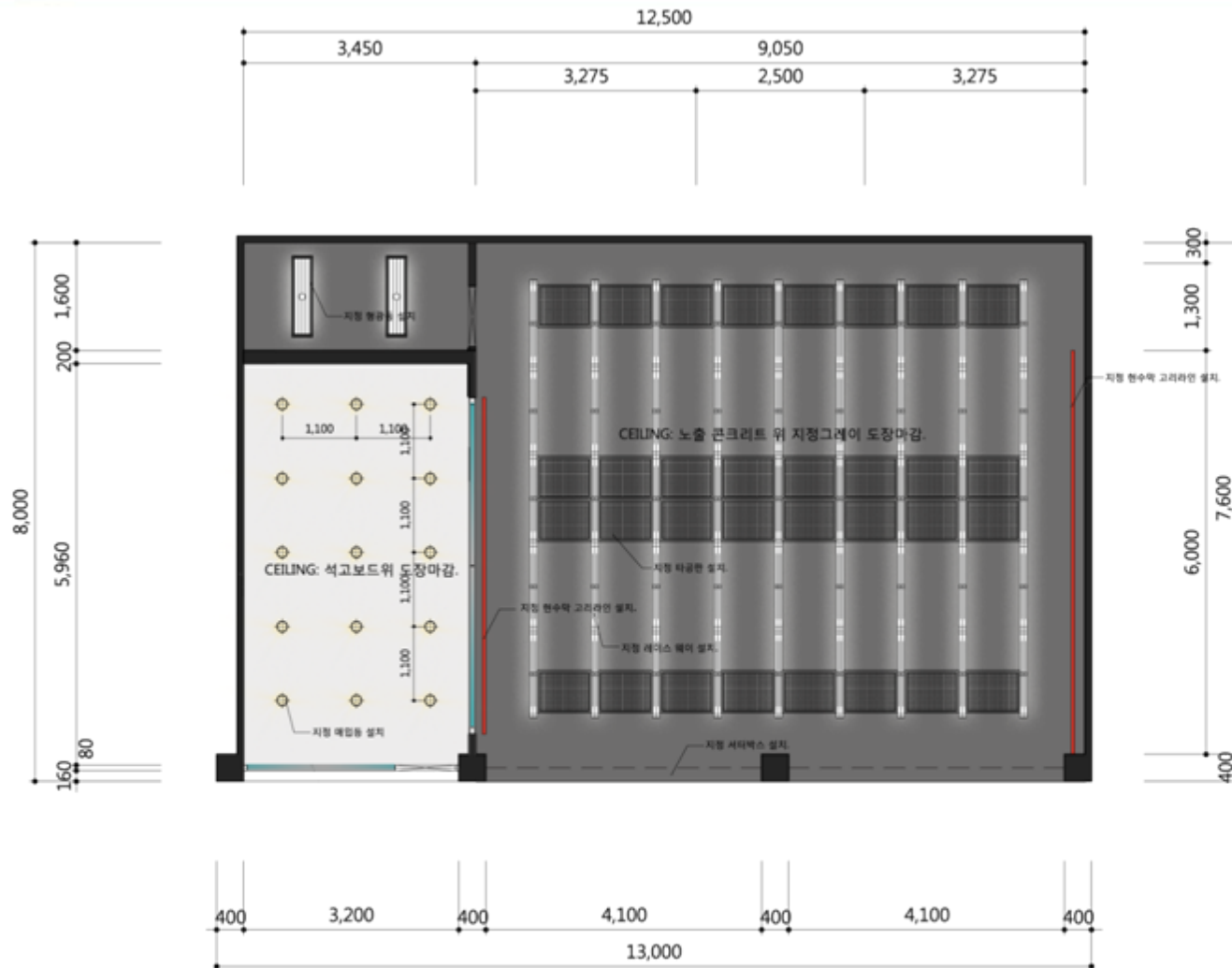

CEILING PLAN-A TYPE
SCALE 1/80

2 BAY
CEILING PLAN-B

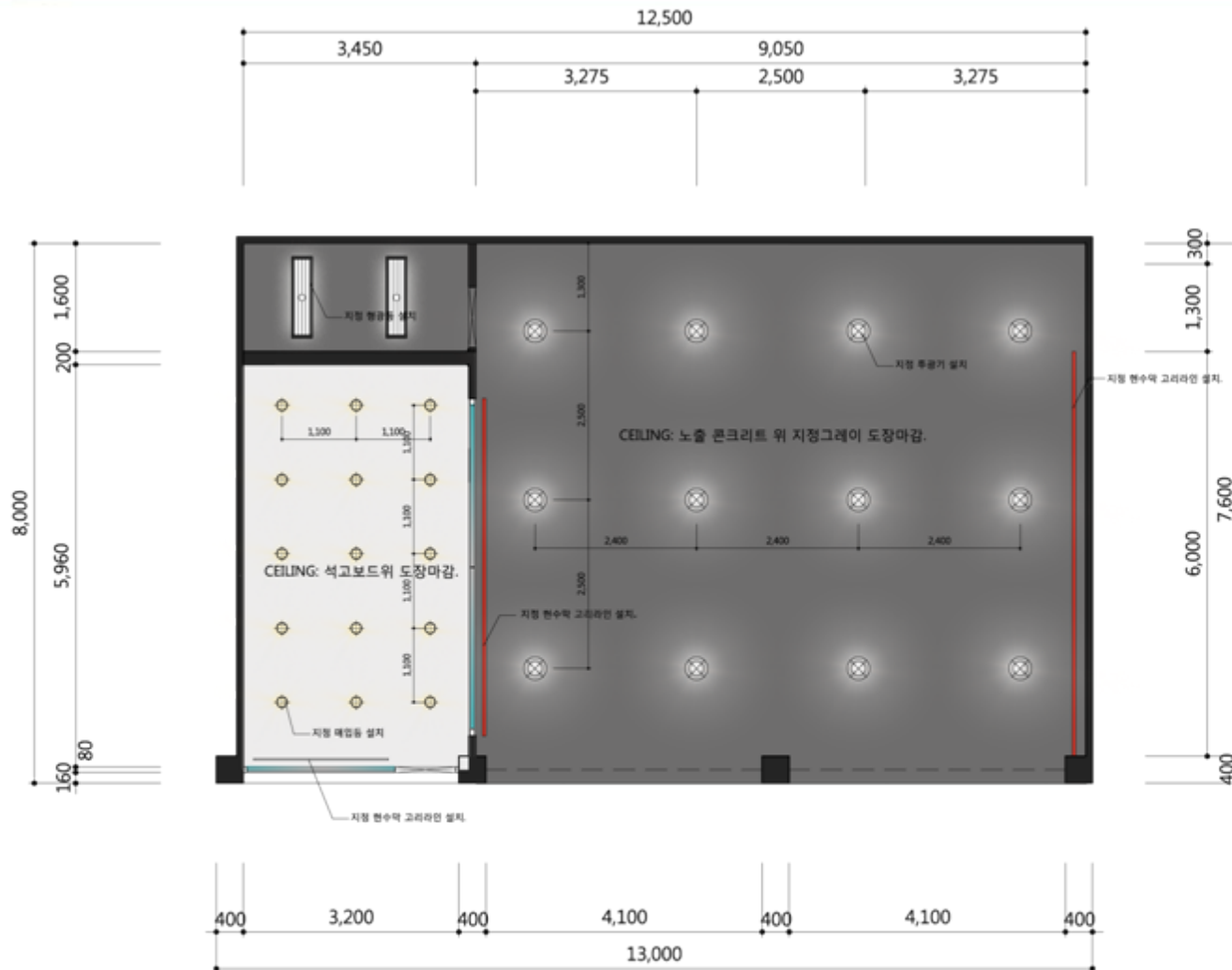

CEILING PLAN-B TYPE
SCALE 1/80

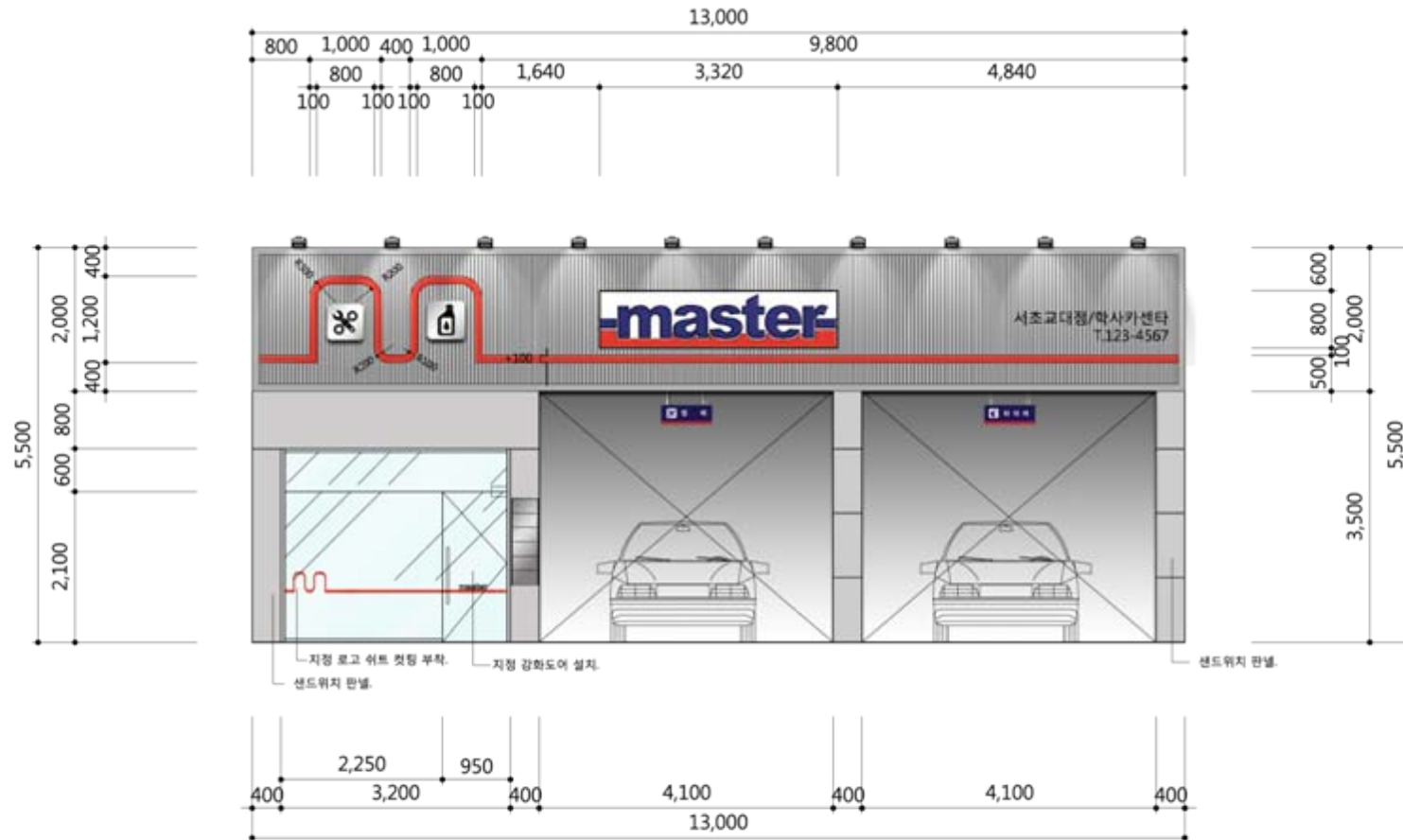

FACADE

SCALE 1/80

2 BAY
작업장 ELEVATION

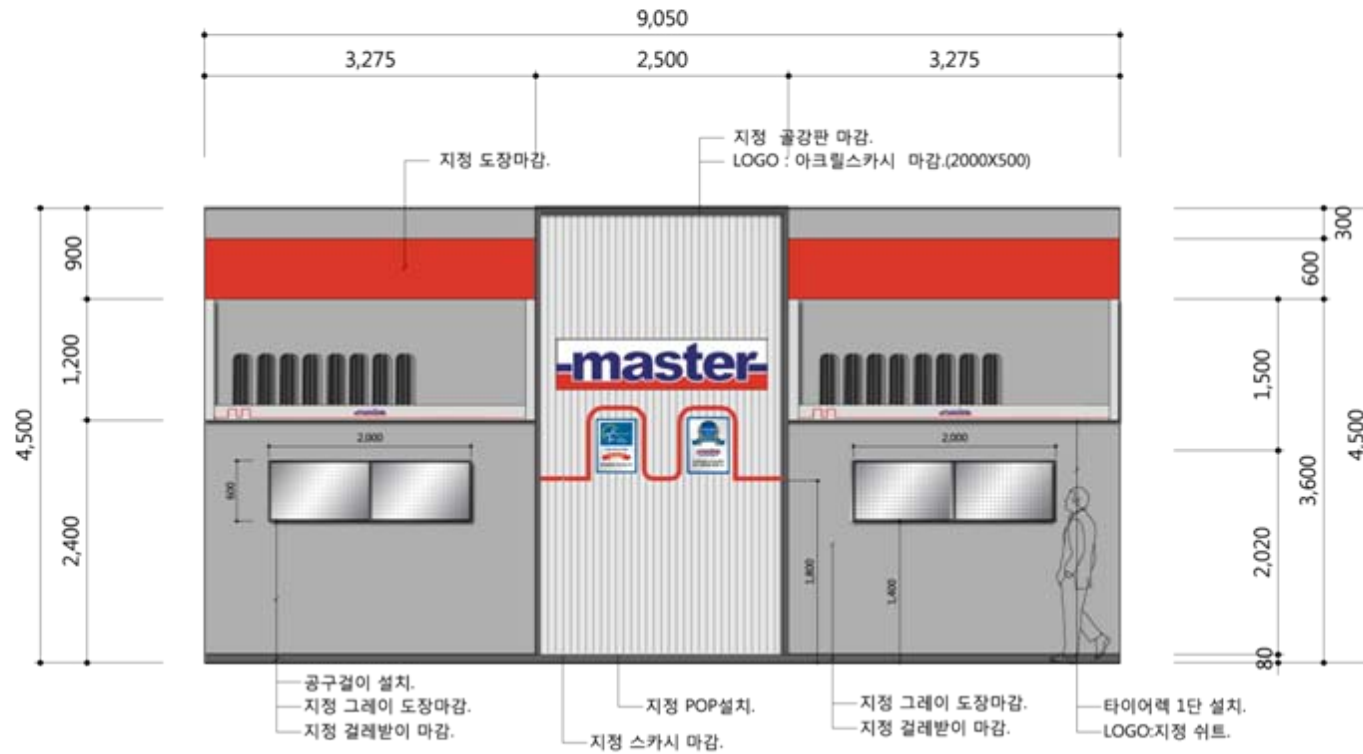

작업장 ELEVATION-A
SCALE 1/60

2 BAY

작업장 ELEVATION

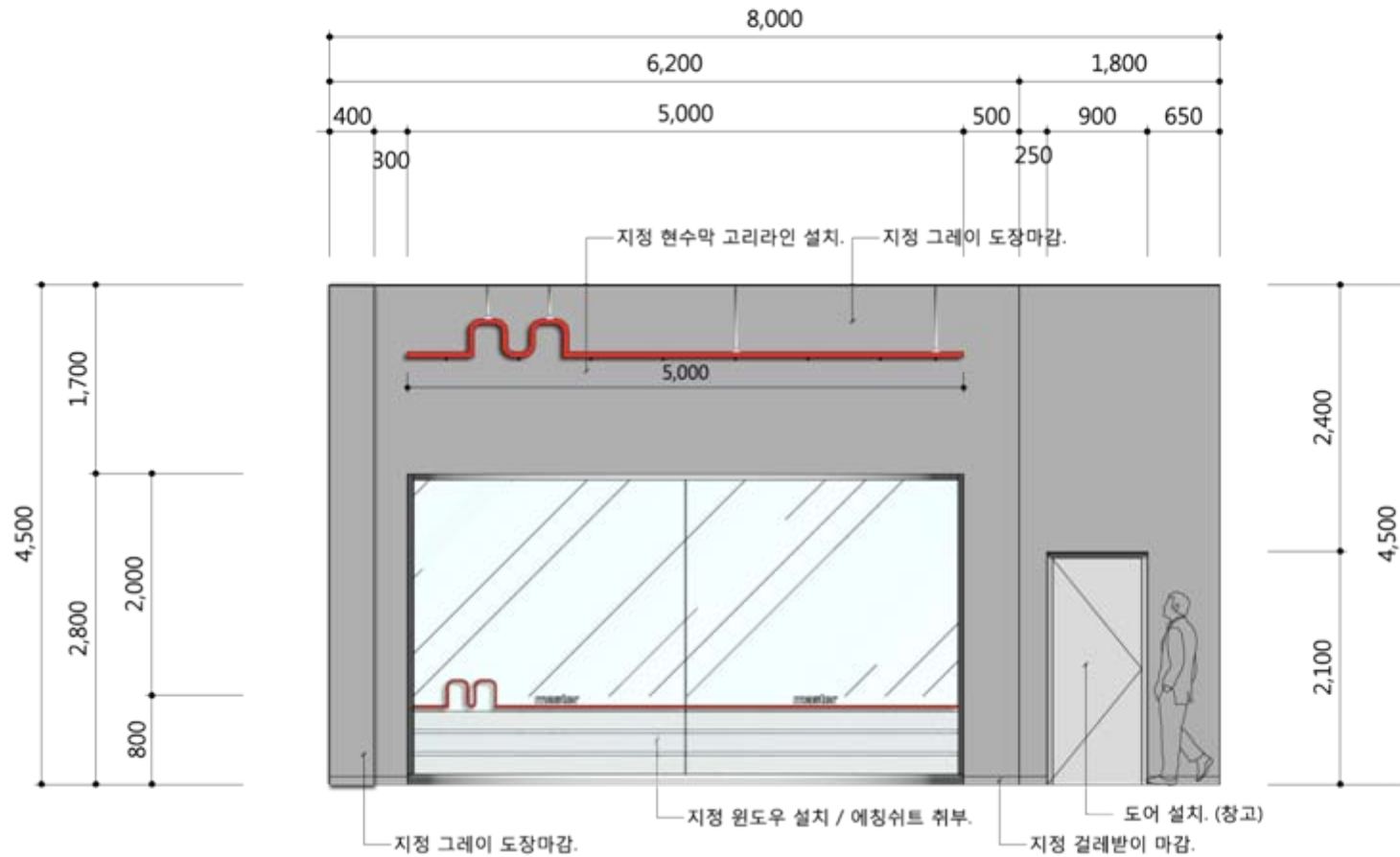

작업장 ELEVATION-B

SCALE 1/60

2 BAY

작업장 ELEVATION

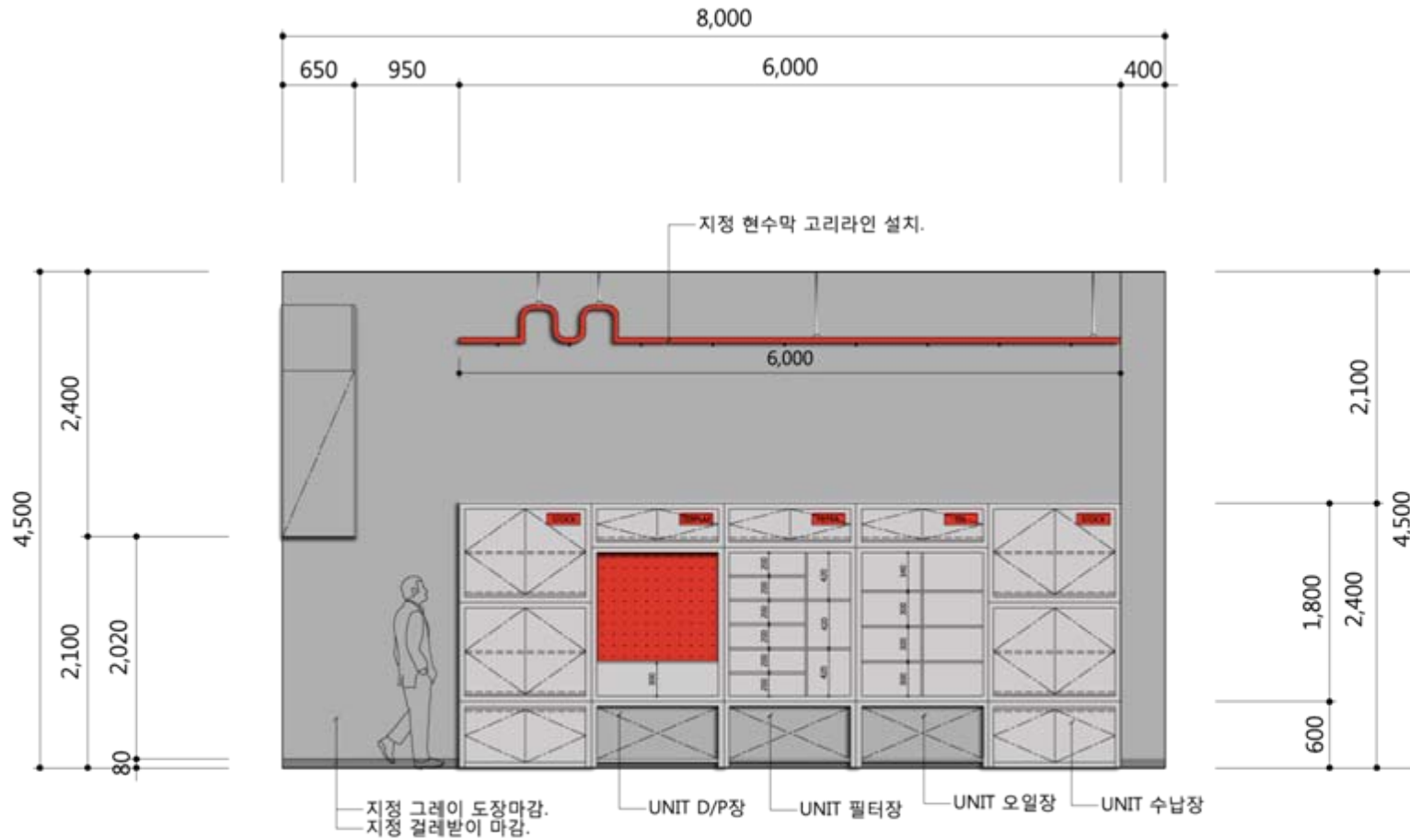

작업장 ELEVATION-C

SCALE 1/60



3 BAY

3 BAY FLOOR PLAN

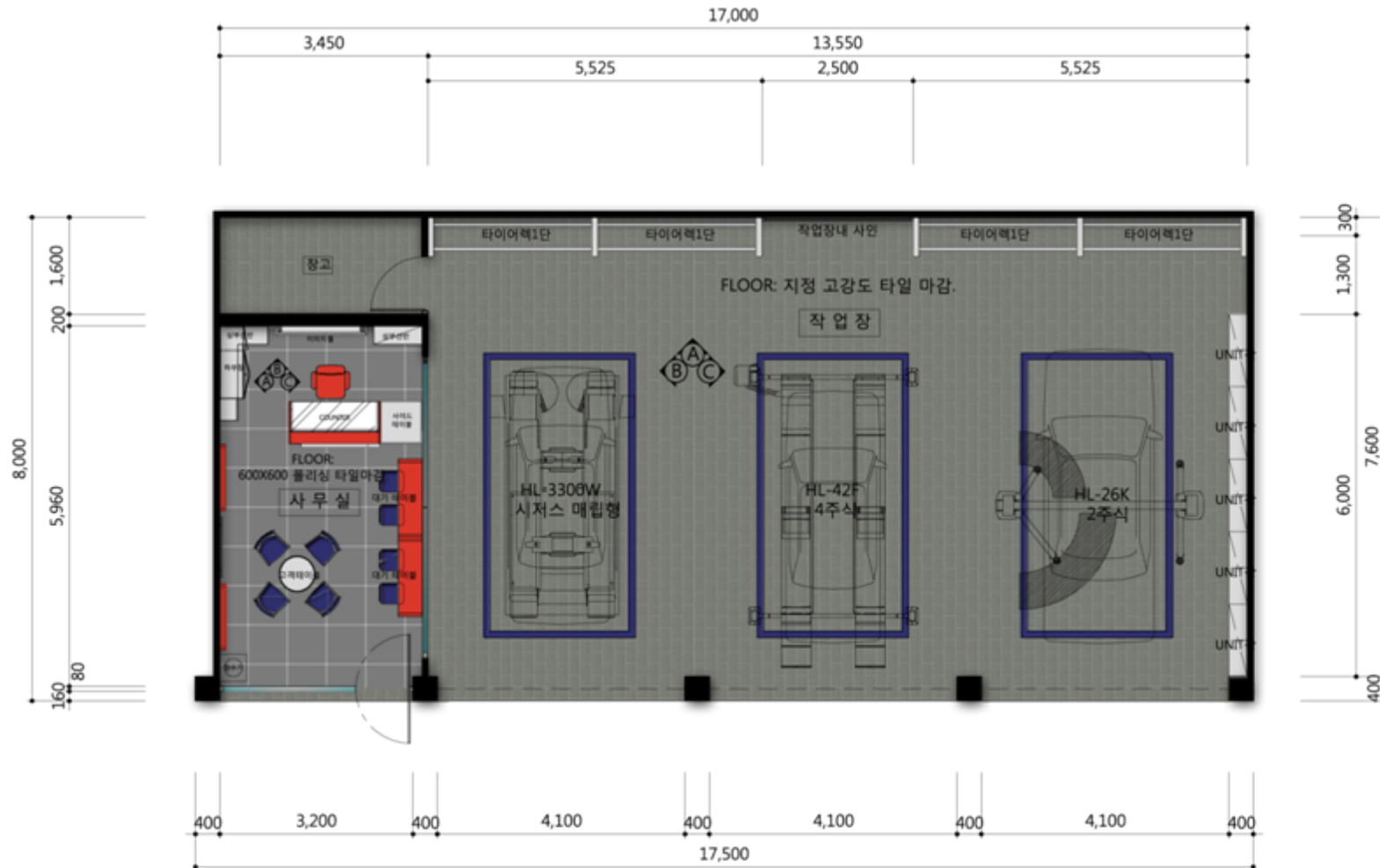

FLOOR PLAN
SCALE 1/80

3 BAY CEILING PLAN-A

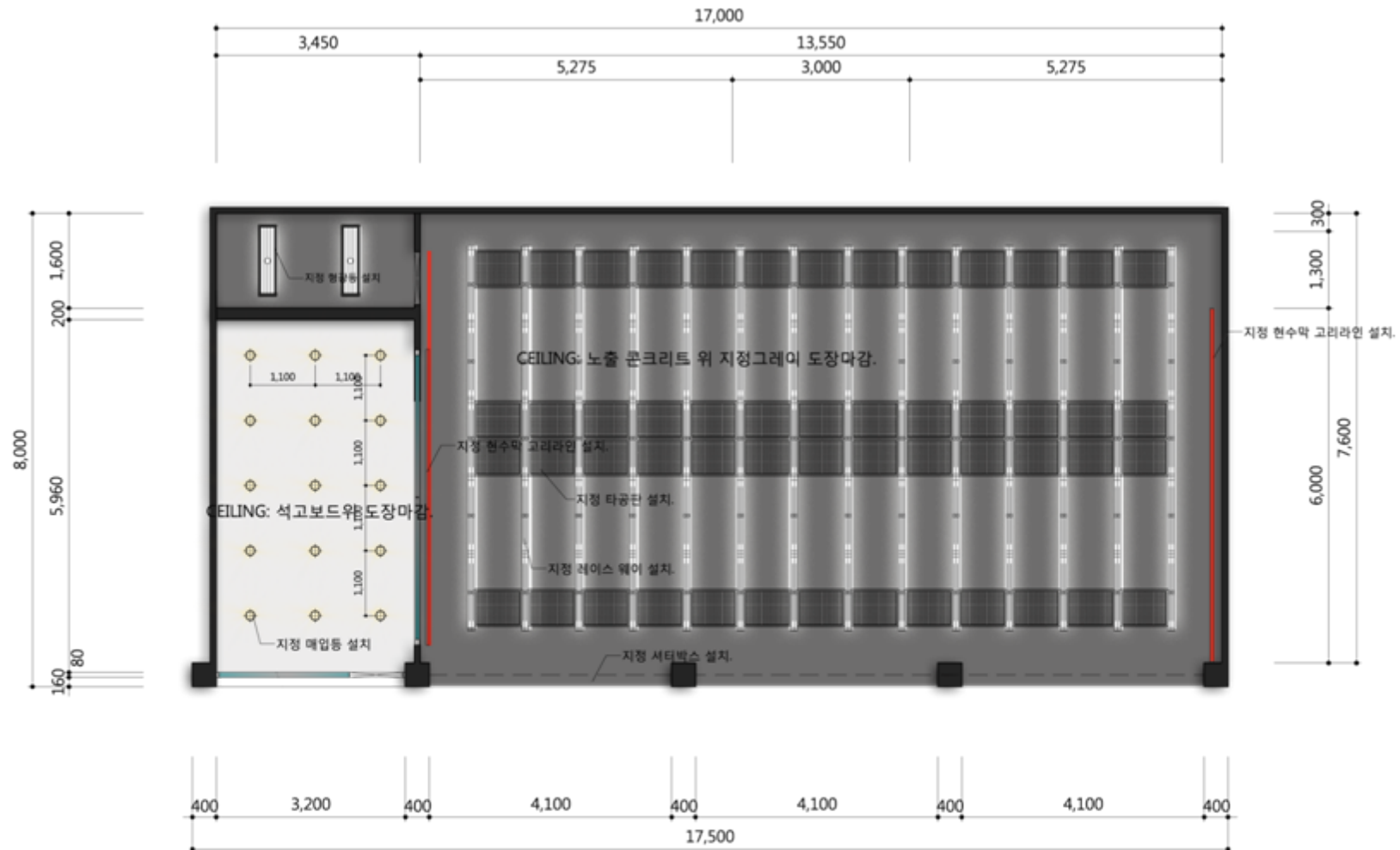

⊙ CEILING PLAN-A TYPE
SCALE 1/80

3 BAY CEILING PLAN-B

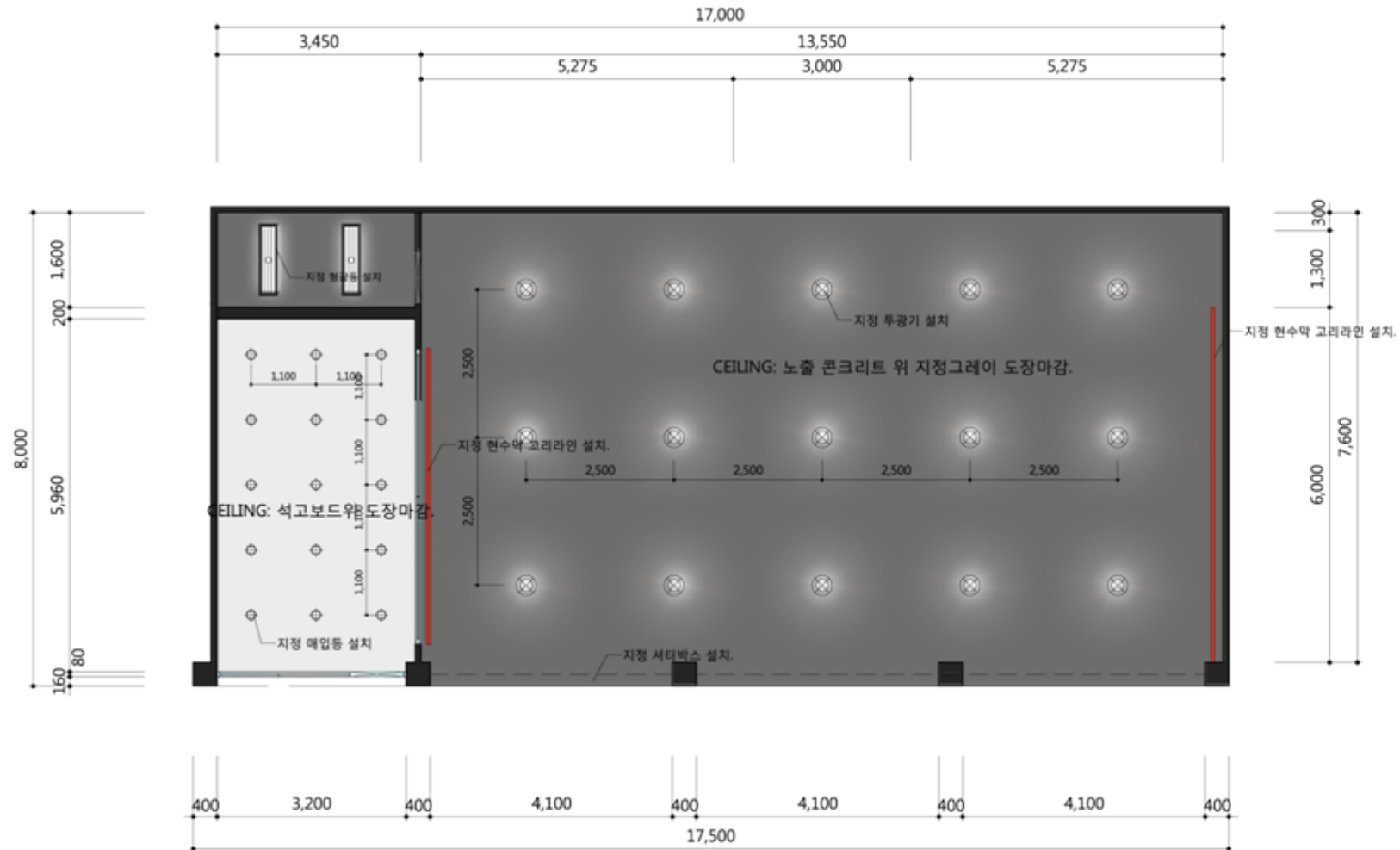

⊙ CEILING PLAN-B TYPE
SCALE 1/80

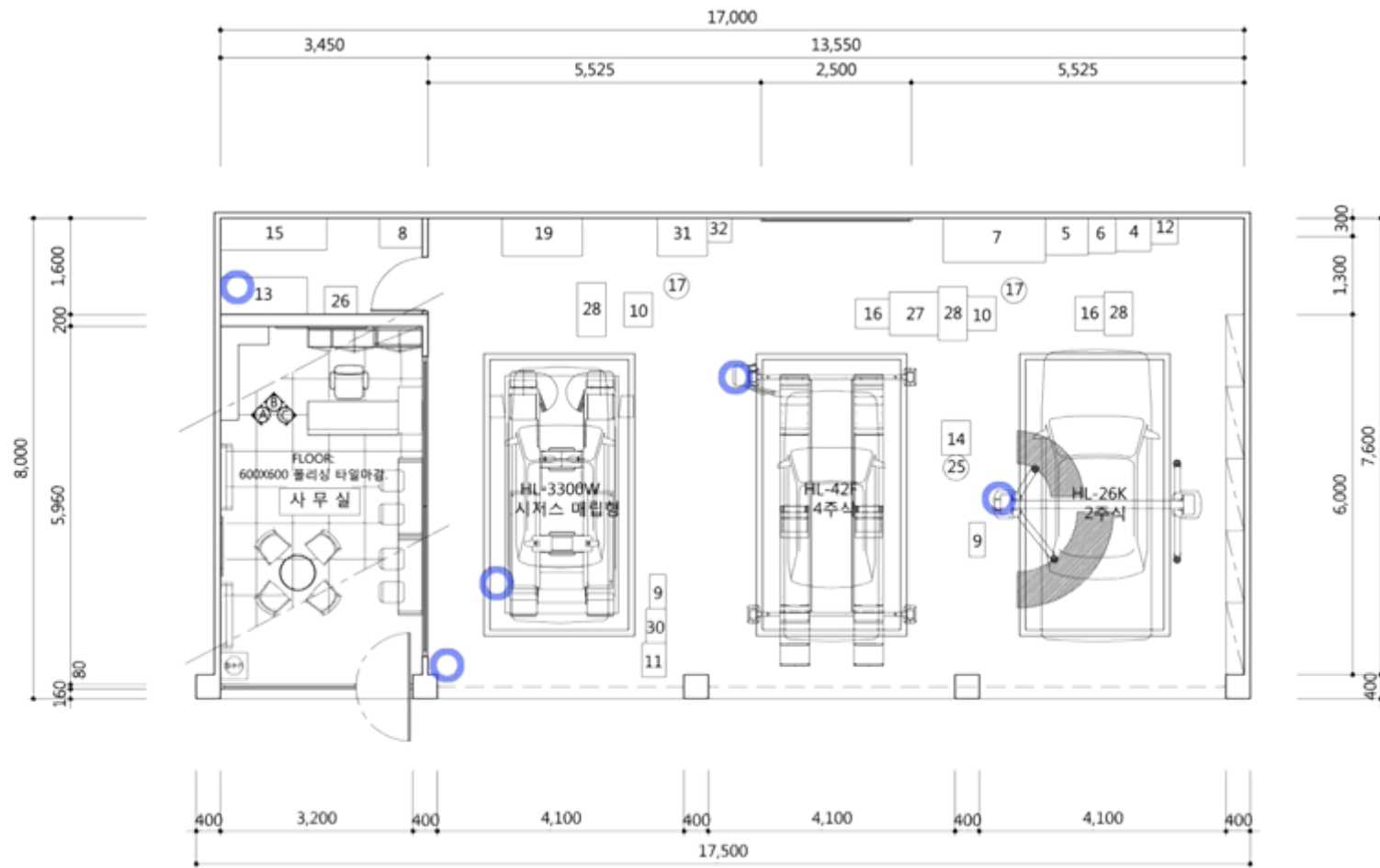

(장비명)

상 품 명	수량	필수	선택
1 카리프트	1	○	
2 카리프트	1	○	
3 카리프트	1	○	
4 부동역회수채장기	1	○	
5 휠발란스	1	○	
6 타이어교환기	1	○	
7 고정식작업대	1		○
8 폐지재함	1		○
9 에어컨	2	○	
10 에어컨/현기등	2	○	
11 안전충격소기	1		○
12 에어컨가스주입기	1		○
13 에어컴프레서	1		○
14 브레이크액교환기	1		○
15 오일드럼	2	○	
16 오일드래인덱스	2	○	
17 자동오일주입기	1		○
18 에어컨	1		○
19 휠알라이먼트	1		○
20 휴대용안전테스트기	1		○
21 태연테스트기	1		○
22 4GAS테스트기	1		○
23 개인공구	3		○
24 공중공구	1		○
25 배터리테스터	1		○
26 부동세척기	1		○
27 제부동역발어	1		○
28 미동식공구대	3		○
29 브레이크액수분측정기	1		
30 개리저차기	1		○
31 뒷선차기	1		○
32 오토뒷손오일교환기	1		○

장비도

SCALE 1/80



3 BAY

에어/오일배관도

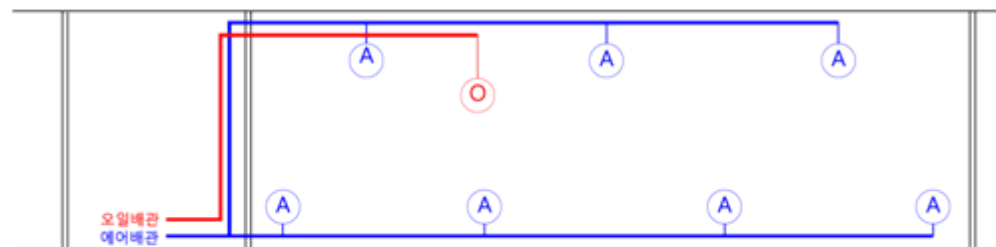
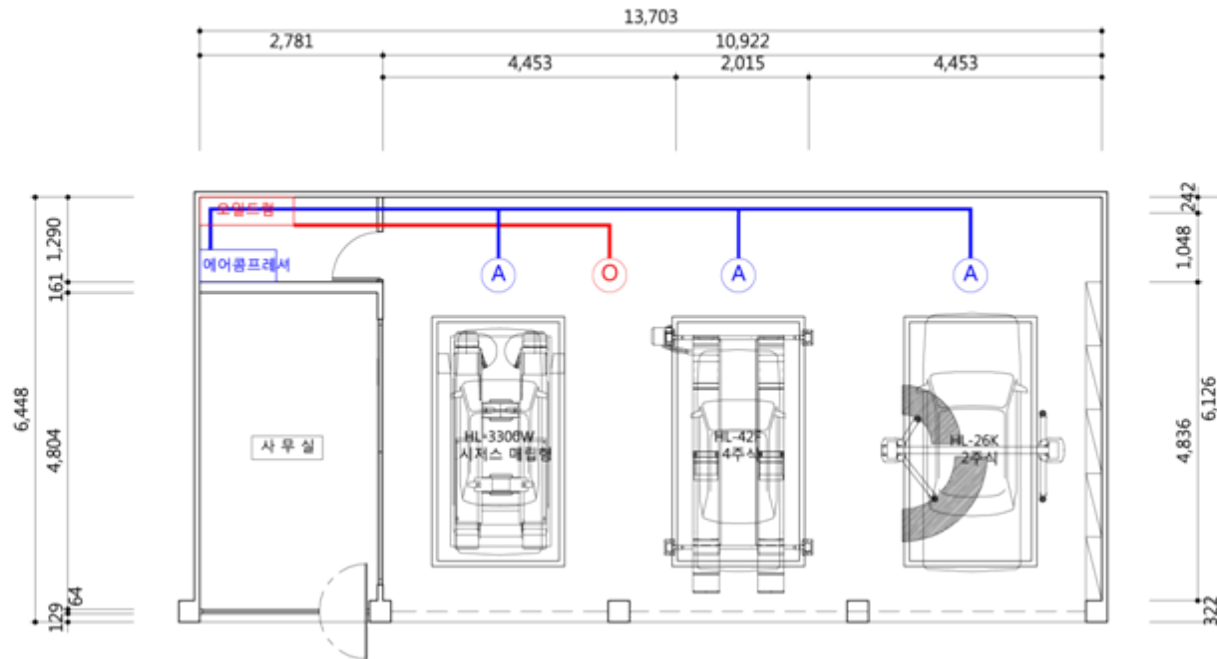

범례

	오일배관
	에어배관

에어 / 오일 배관도
SCALE 1/80

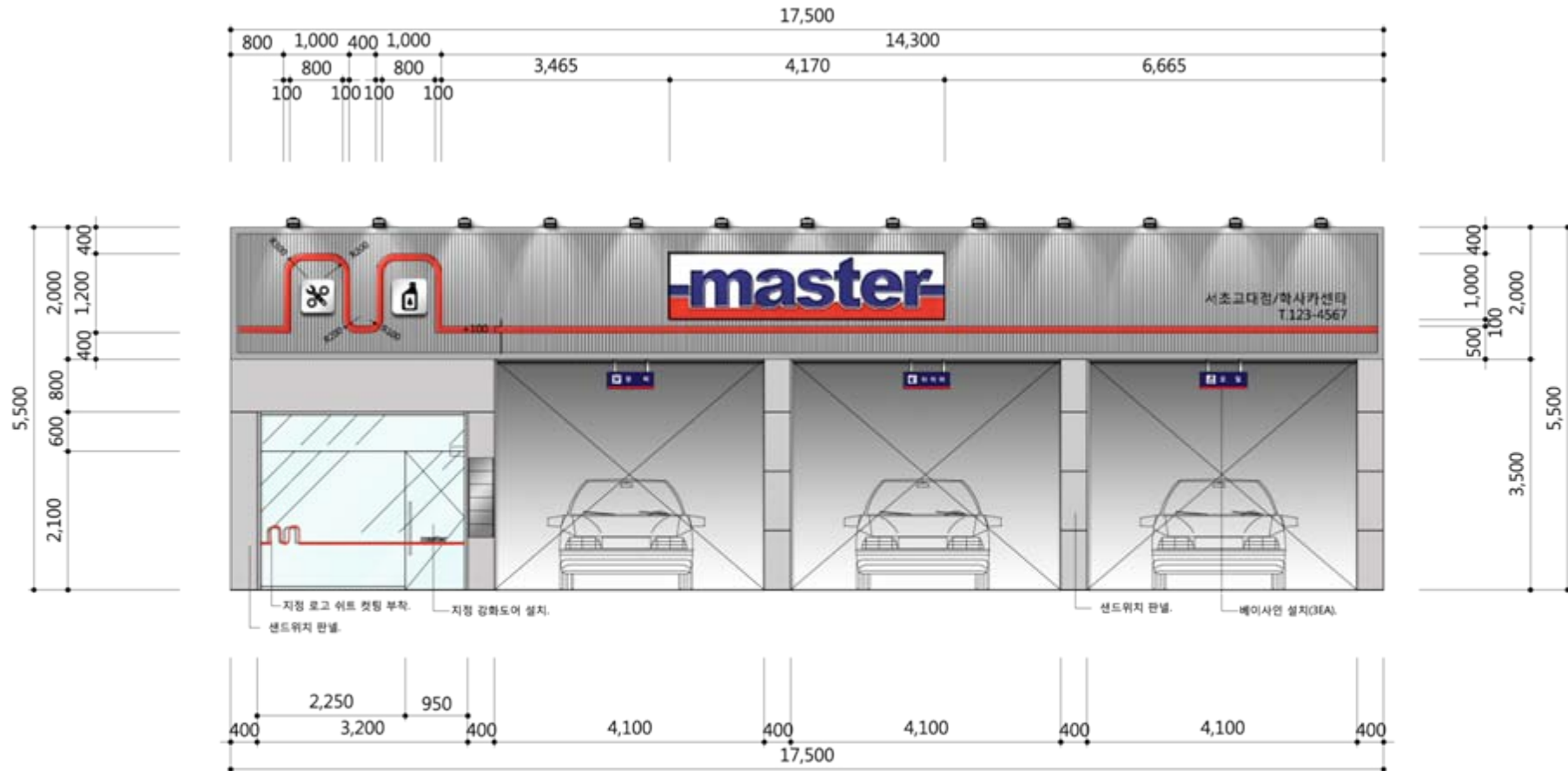

FACADE

SCALE 1/80

3 BAY

작업장 ELEVATION

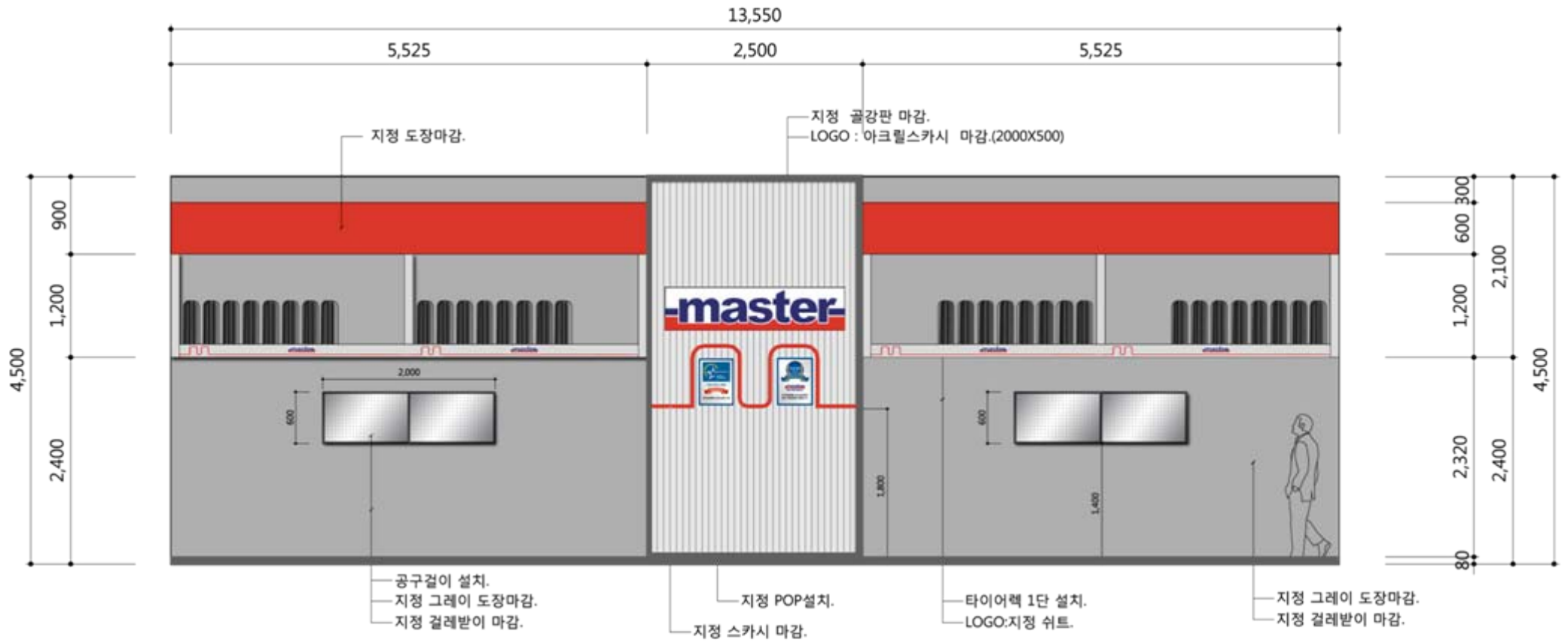

작업장 ELEVATION-A

SCALE 1/60

3 BAY

작업장 ELEVATION

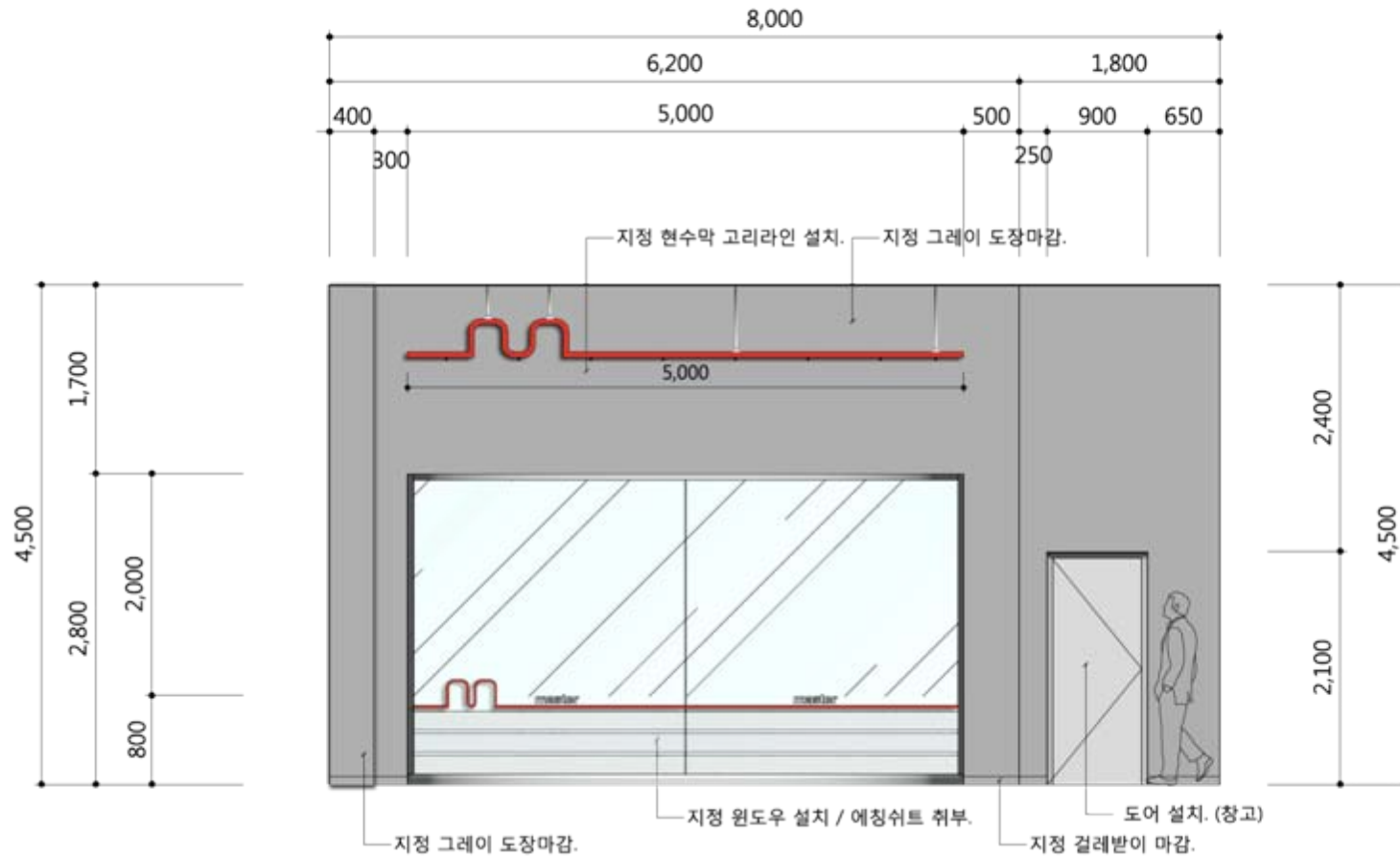

작업장 ELEVATION-B

SCALE 1/60

3 BAY

작업장 ELEVATION

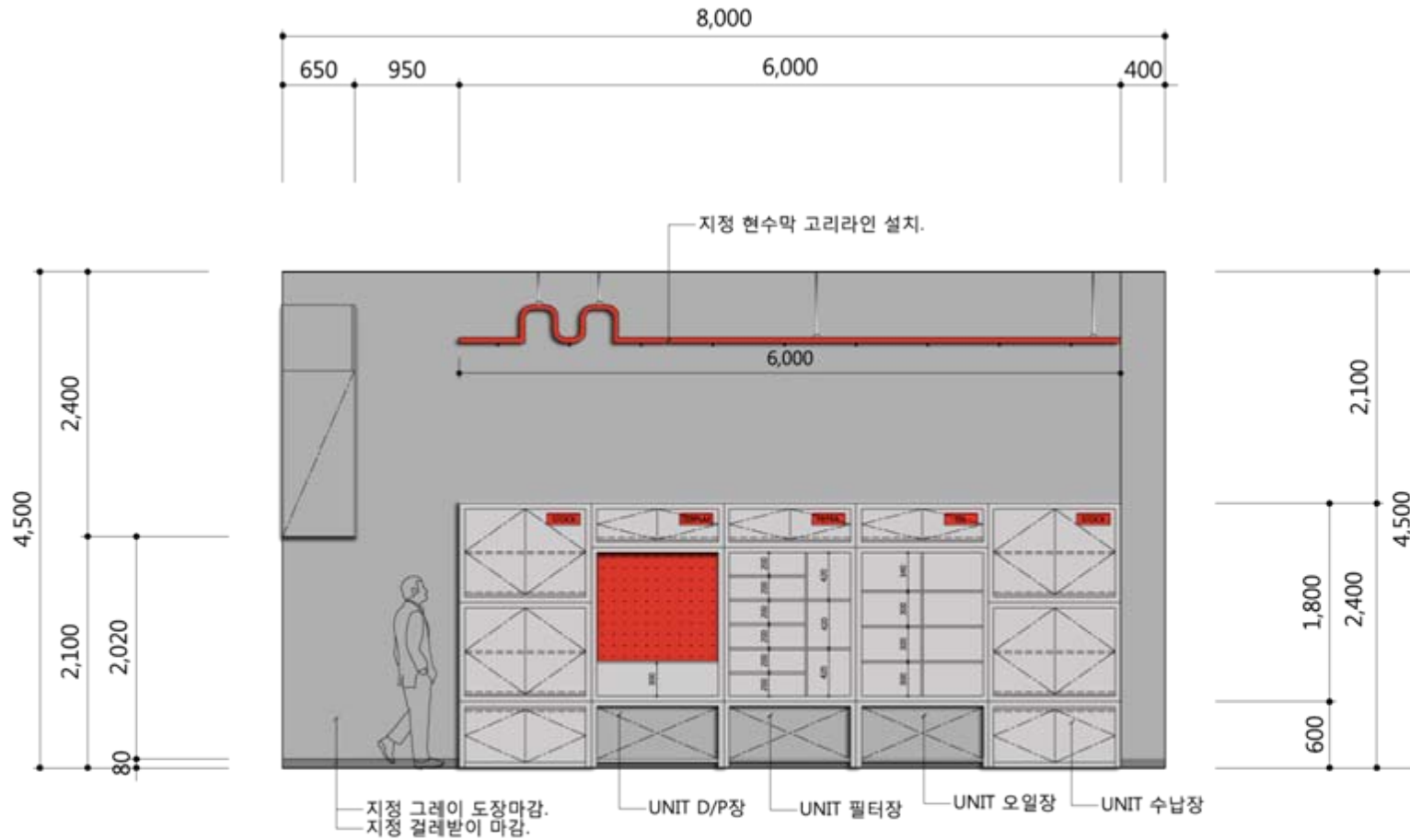

작업장 ELEVATION-C

SCALE 1/60



3 BAY

사무실 ELEVATION

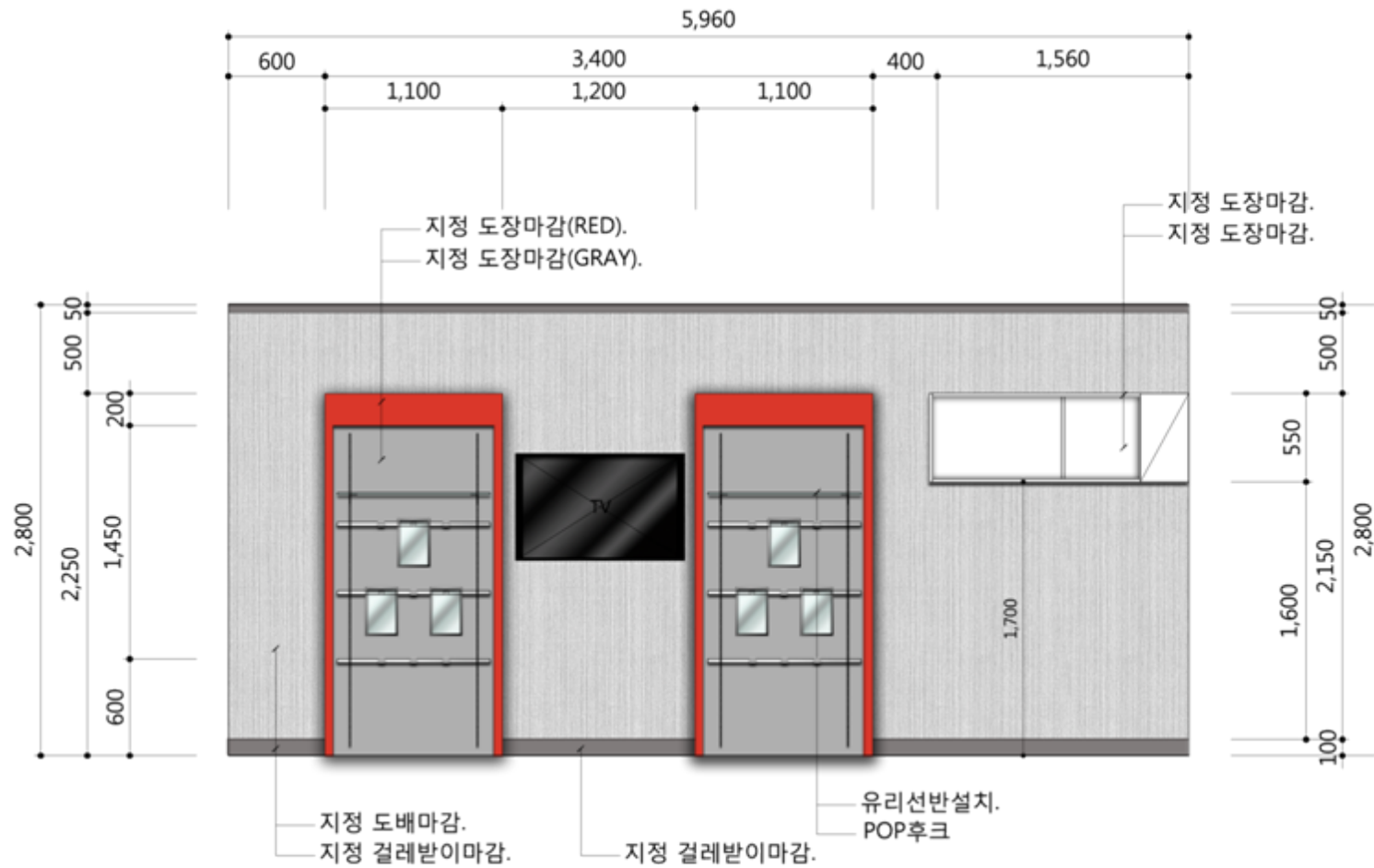

사무실 ELEVATION-A

SCALE 1/30

3 BAY

사무실 ELEVATION

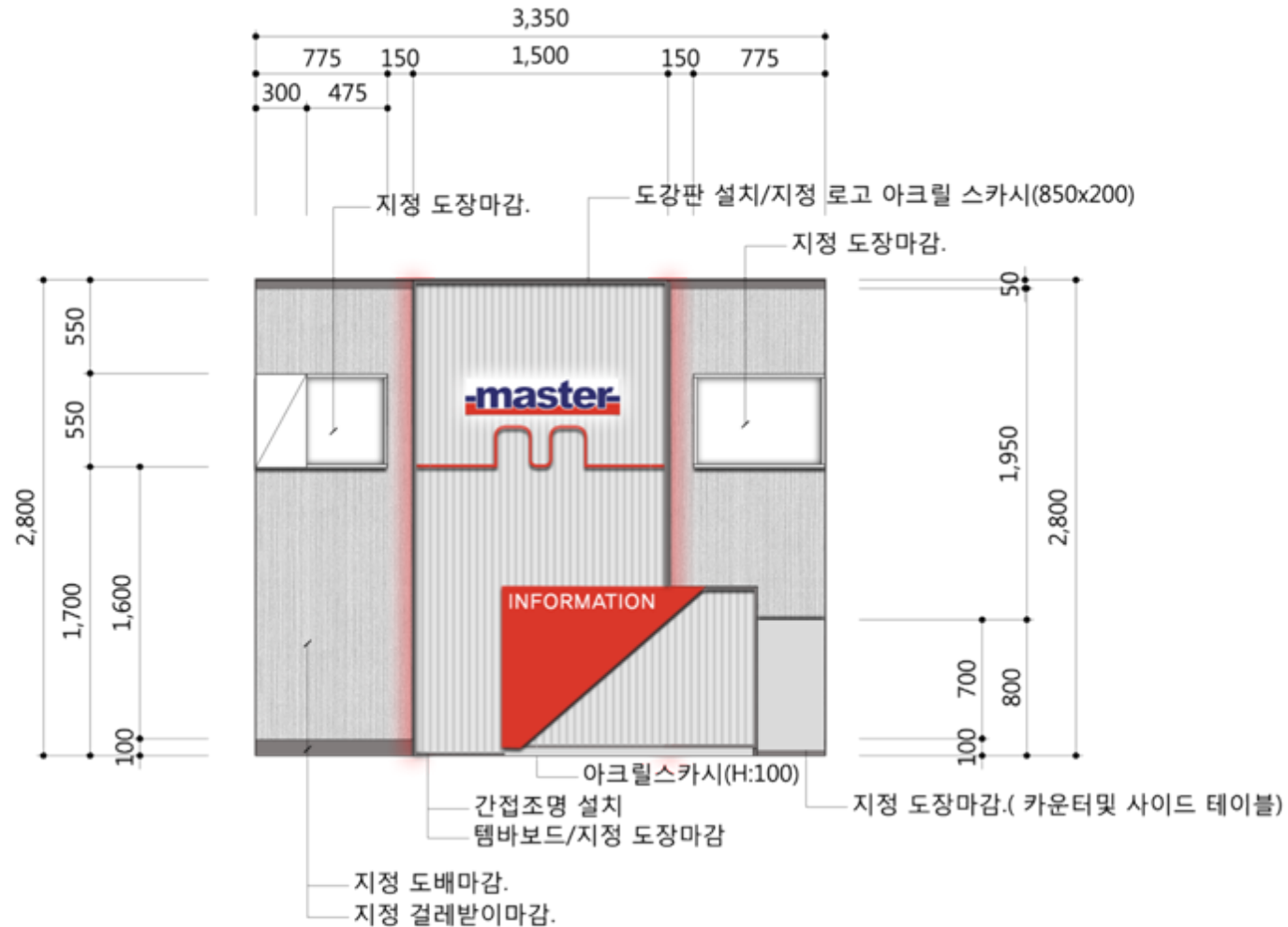

사무실 ELEVATION-B

SCALE 1/30

3 BAY

사무실 ELEVATION

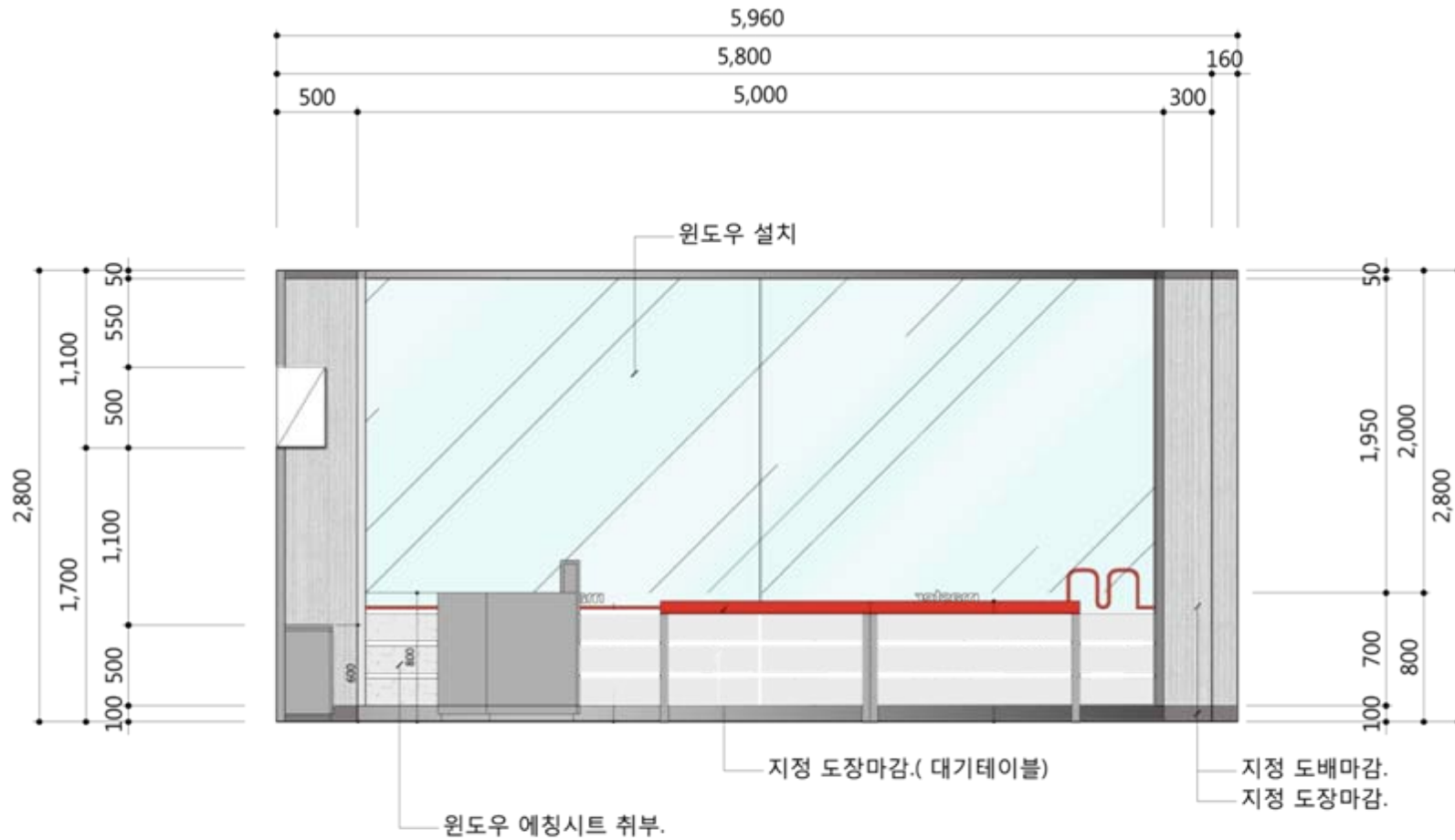

사무실 ELEVATION-C
SCALE 1/30







-master-

3 BAY

FACAD-주간
3D VIEW







4 BAY

4 BAY FLOOR PLAN

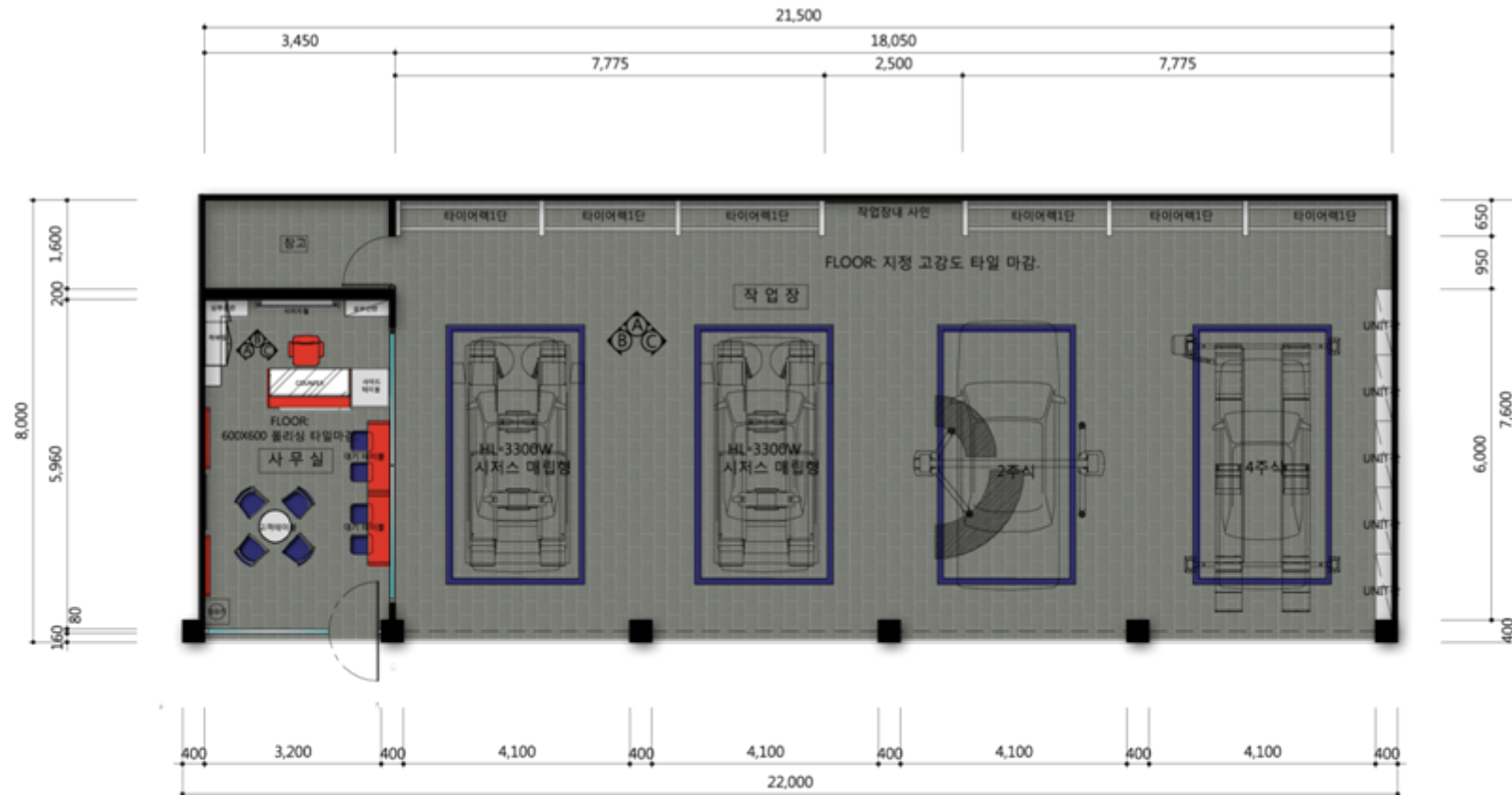

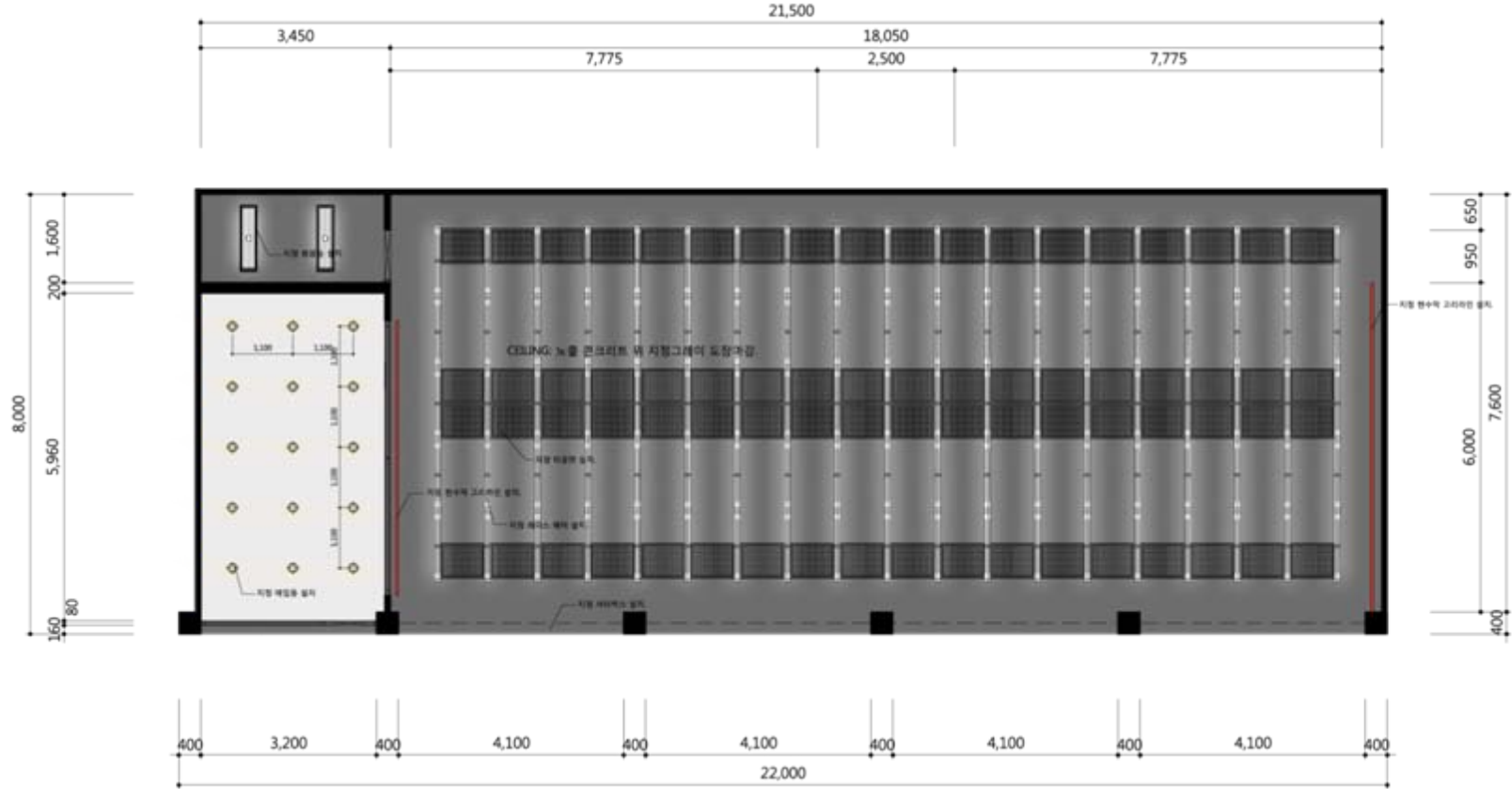

FLOOR PLAN
 SCALE 1/100

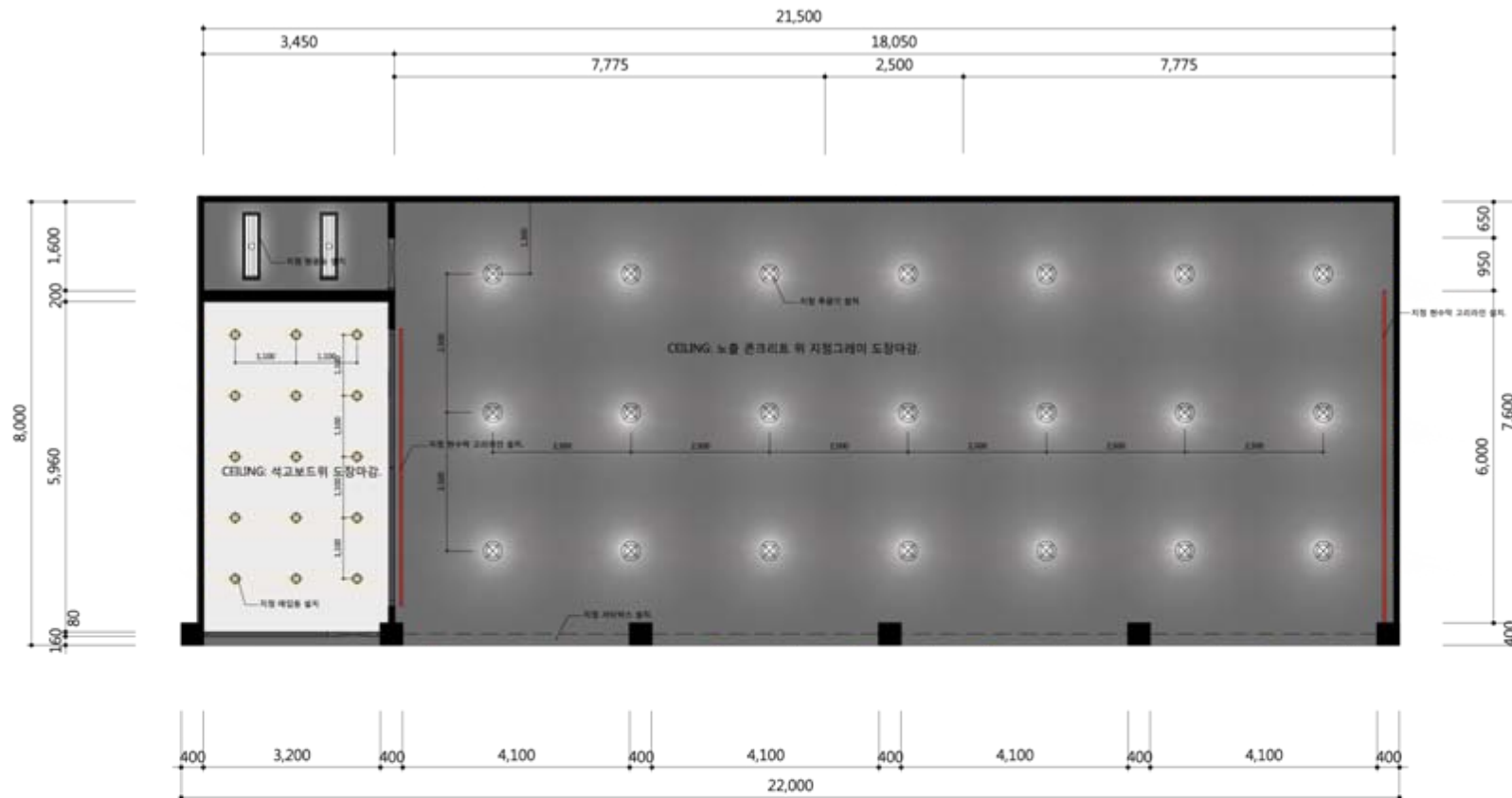

⊕ CEILING PLAN-A TYPE
SCALE 1/100

4 BAY CEILING PLAN-B



CEILING PLAN-B TYPE
 SCALE 1/100

4 BAY
FACADE

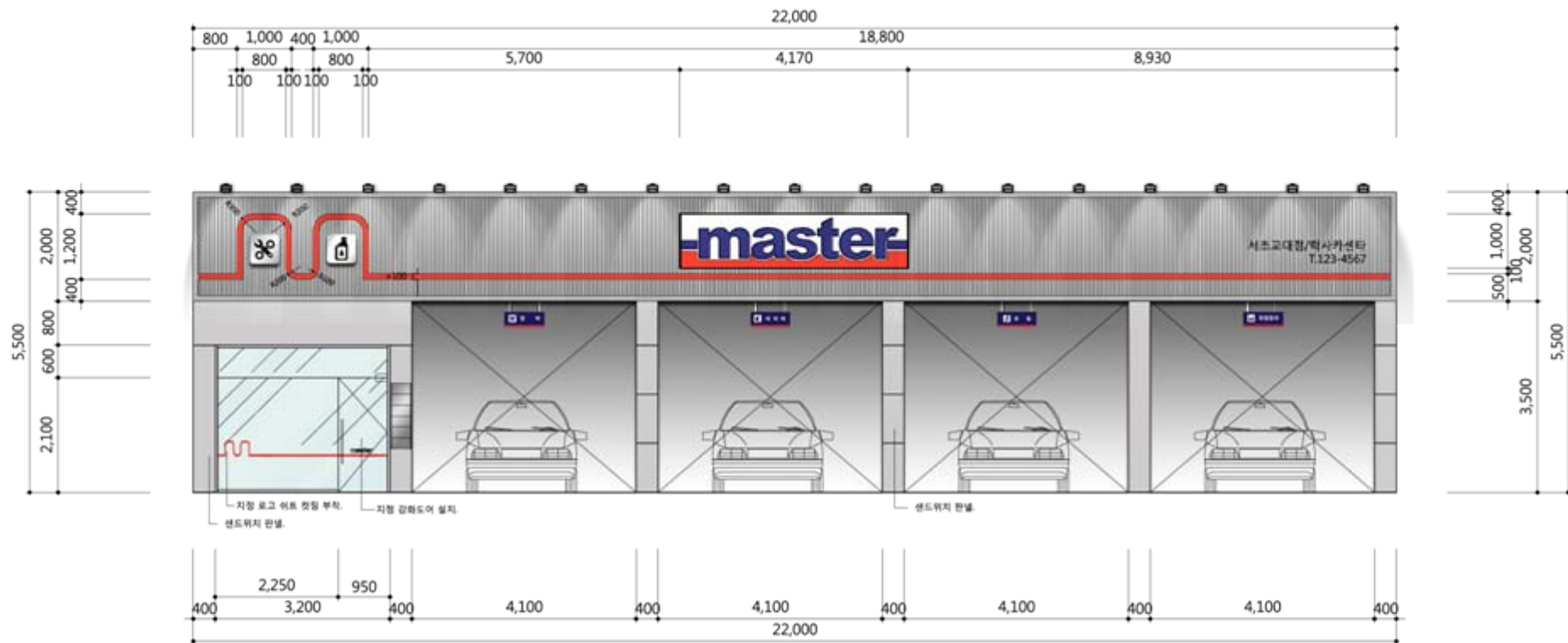

FLOOR PLAN
SCALE 1/100

4 BAY

작업장 ELEVATION

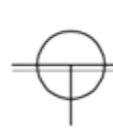
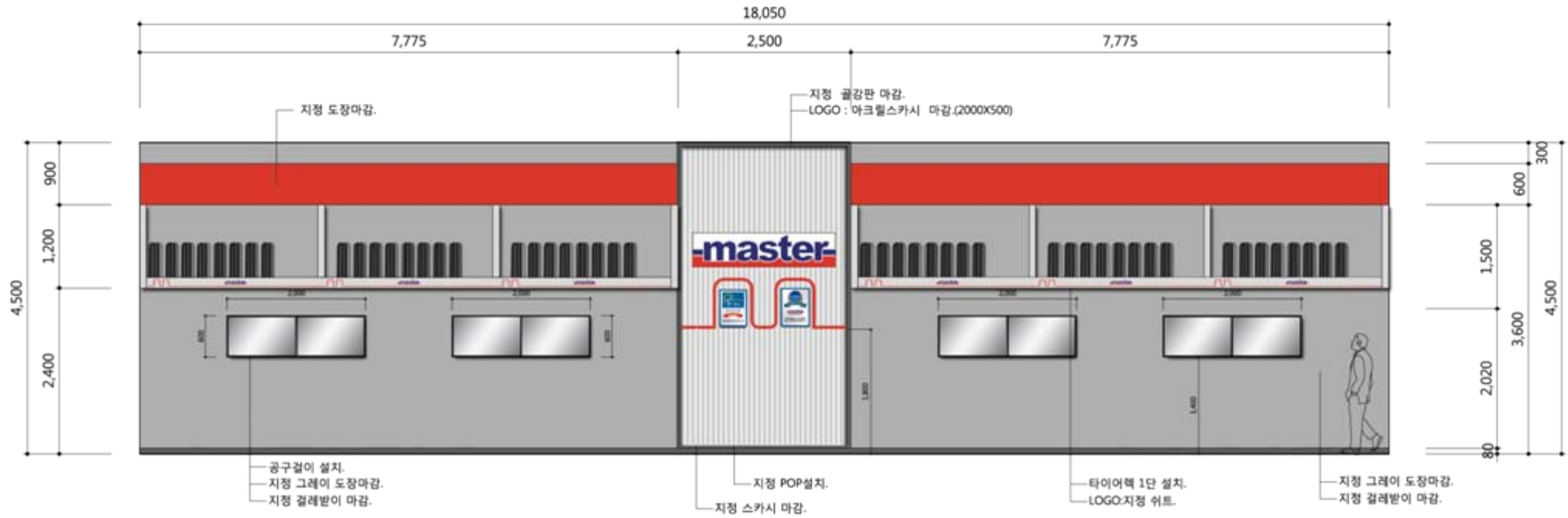

작업장 ELEVATION-A

SCALE 1/80

4 BAY

작업장 ELEVATION

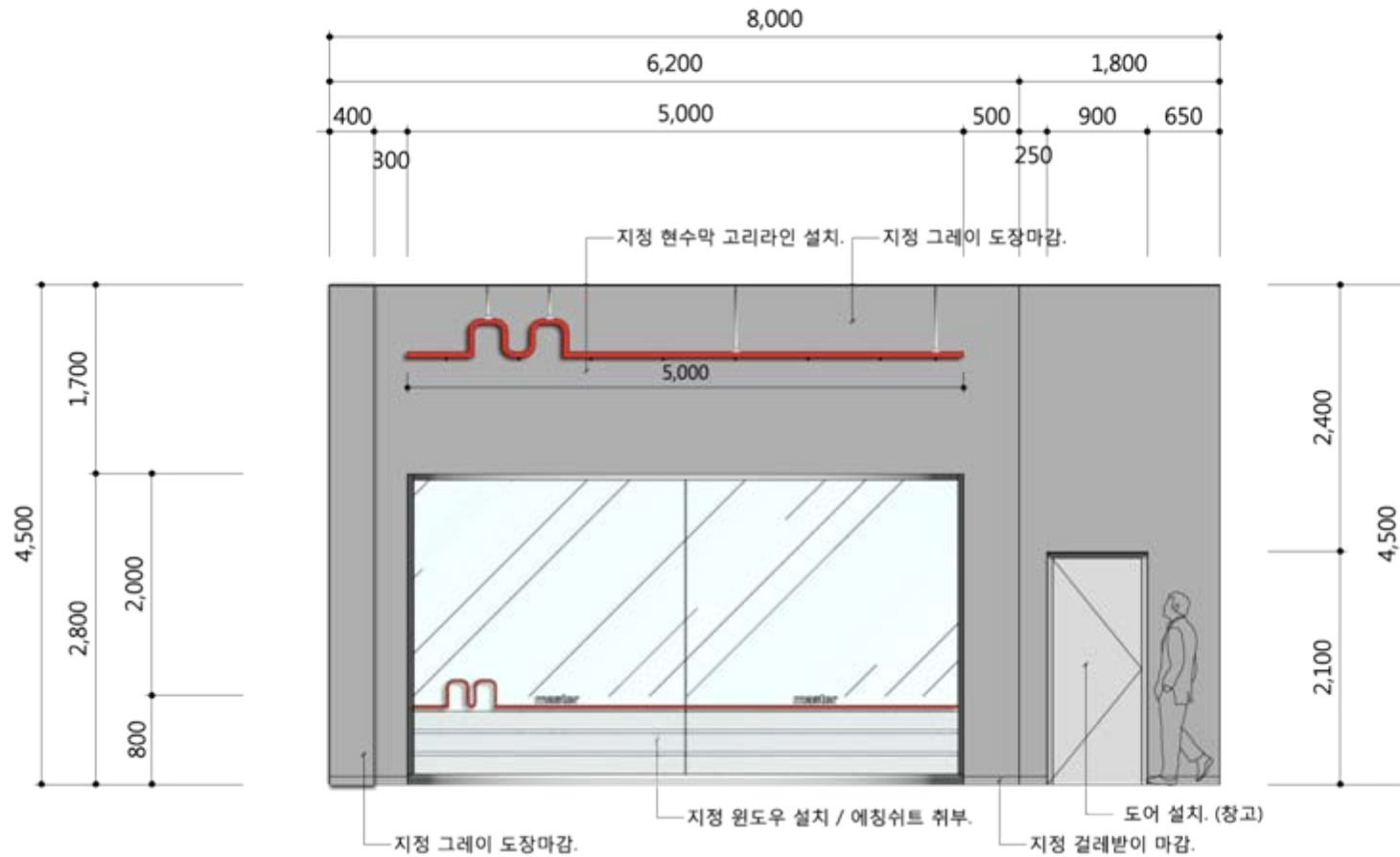

작업장 ELEVATION-B

SCALE 1/60

4 BAY

작업장 ELEVATION

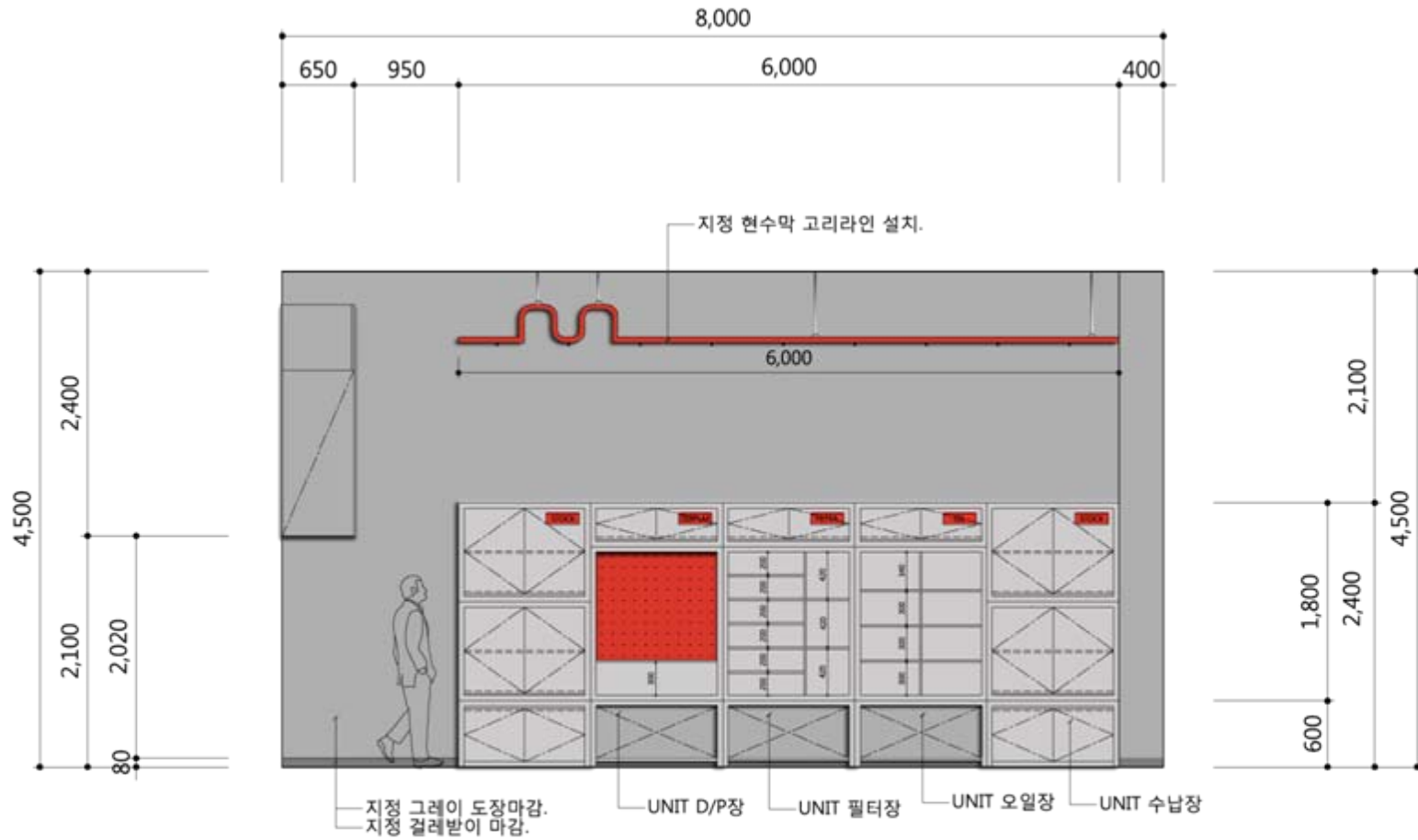

작업장 ELEVATION-C

SCALE 1/60





공사상세도

공사상세도
공구걸이

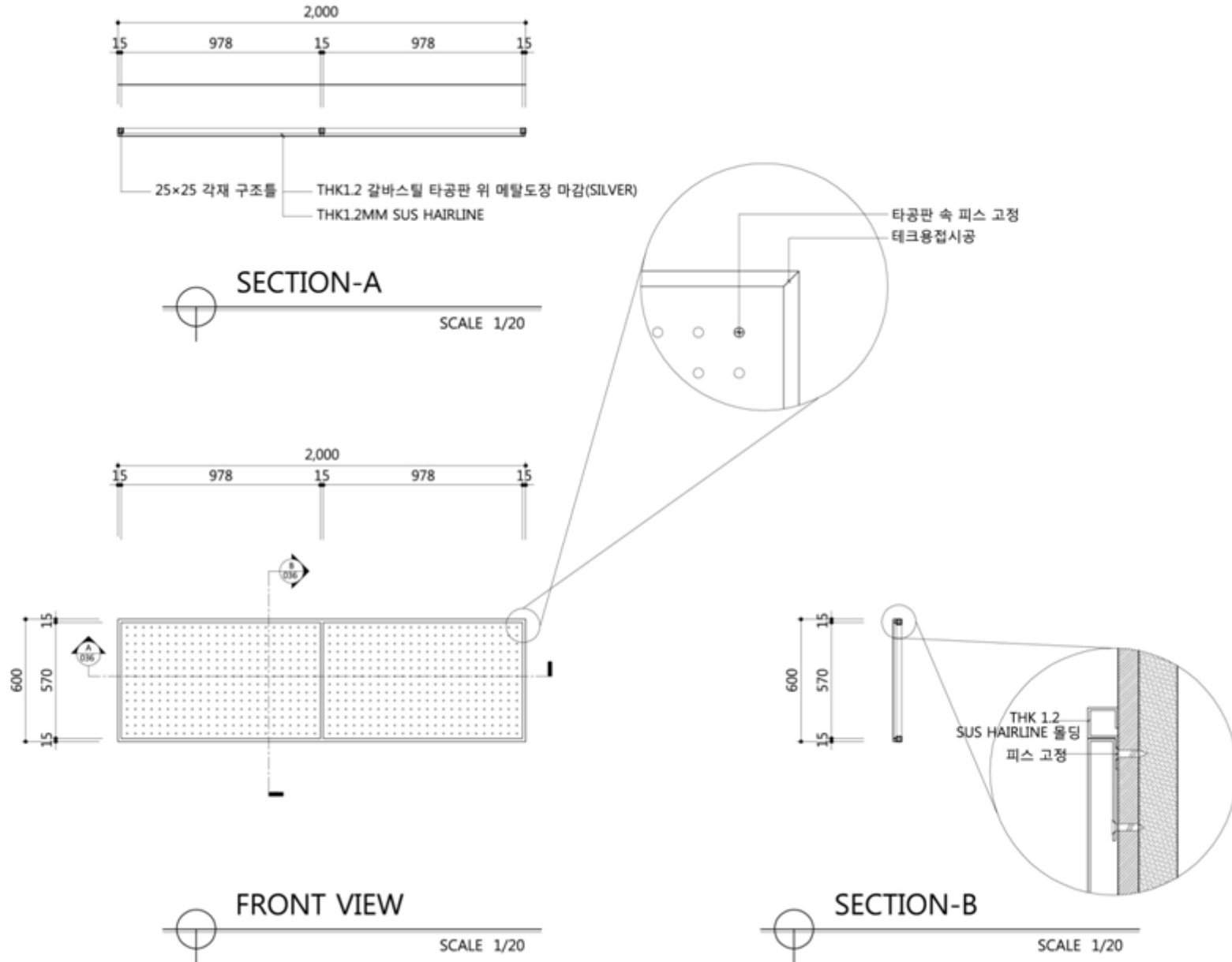

공사상세도 어닝

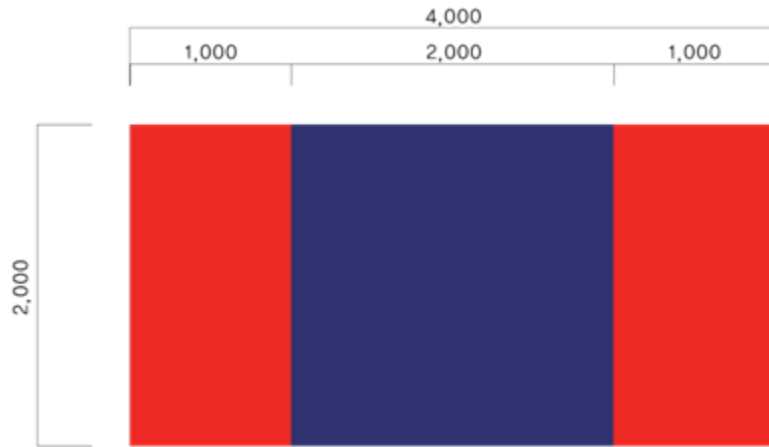

지정 로고 워트 컷팅 부착.
샌드위치 판넬.

지정 강화도어 설치.

샌드위치 판넬.

베이션 설치(3EA).

공사상세도
"M"-LINE현수막 걸이



PERSPECTIVE
SCALE 1/20

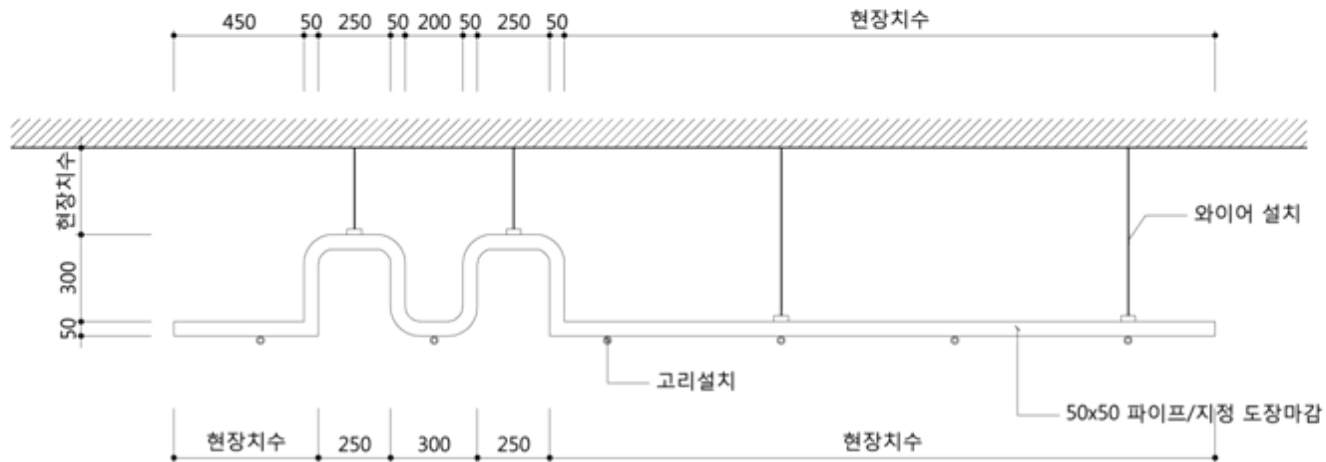

"M"-LINE 현수막 걸이
SCALE 1/20



FURNITURE

FURNITURE

타이어랙 1단

- 50X50 2.1T
- 100X50 1.4T

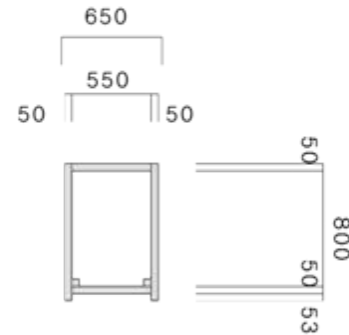

질곡도면(1.2T)

FURNITURE

타이어랙 2단



- 50X50 2.1T
- 100X50 1.4T

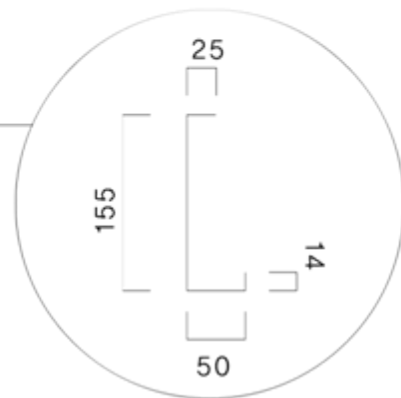
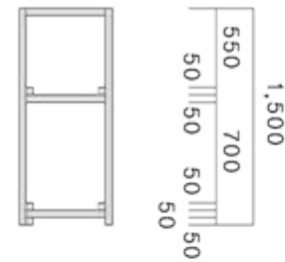
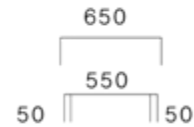
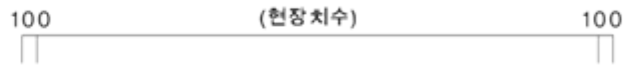

질곡도면(1.2T)

FURNITURE

타이어랙 3단

- 50X50 2,1T
- 100X50 1,4T

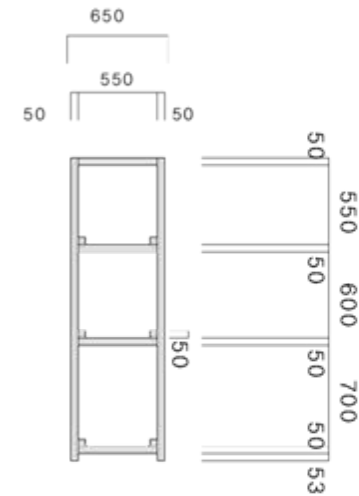
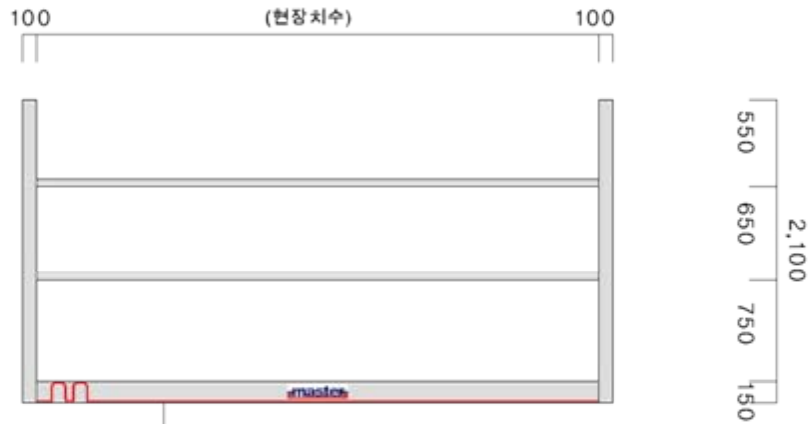

질곡도면(1,2T)

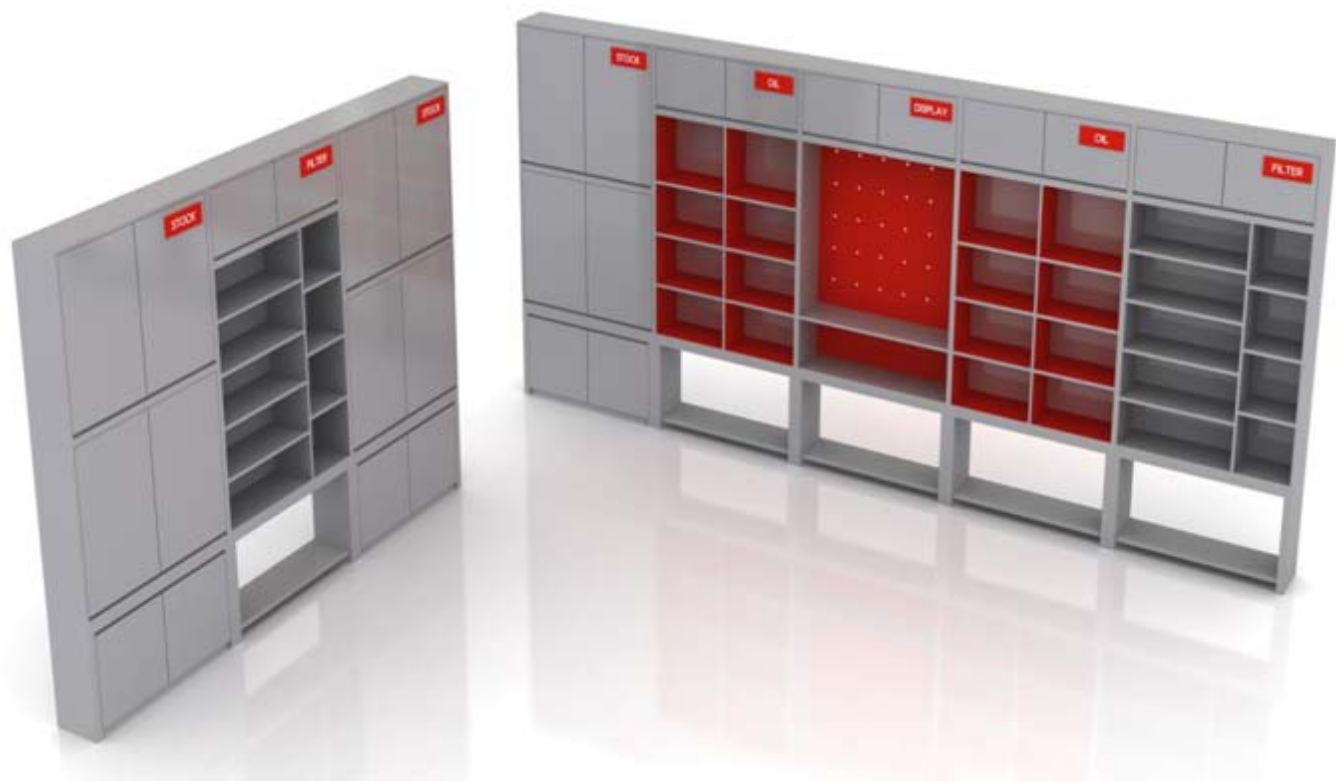

FURNITURE
작업장 UNIT장

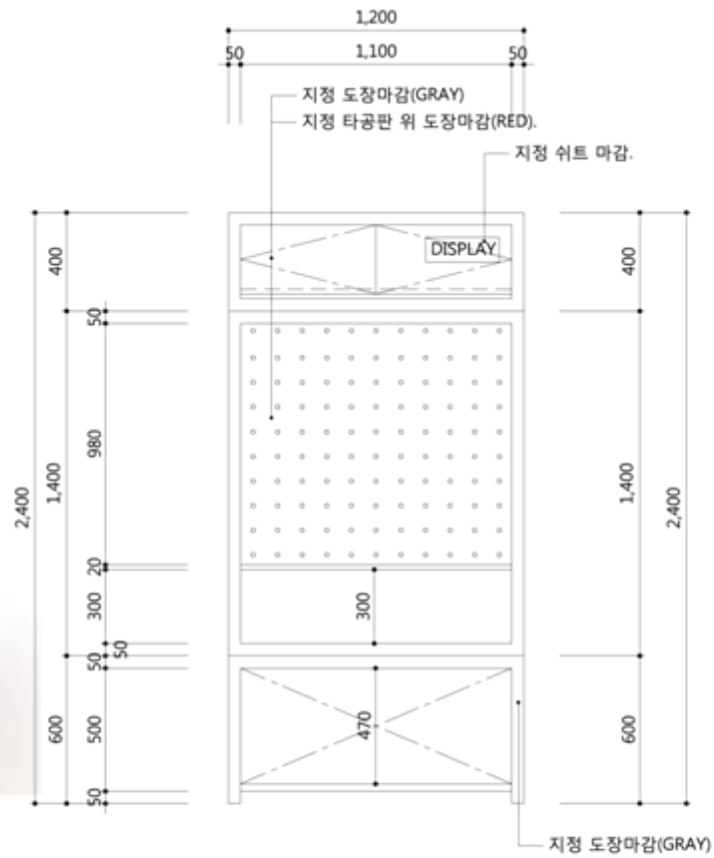

DISPLAY
SCALE 1/20

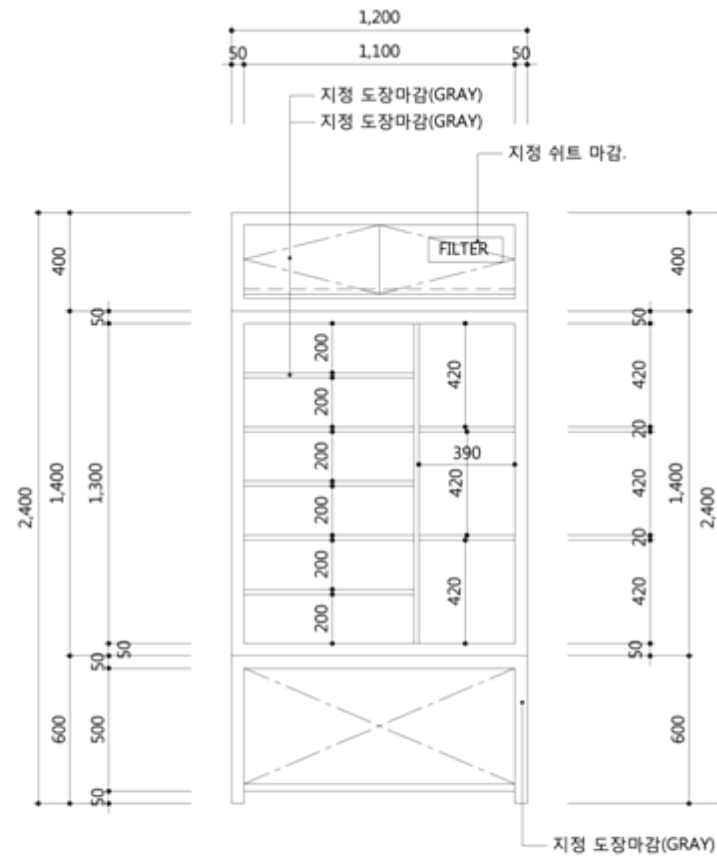

FILTER
SCALE 1/20



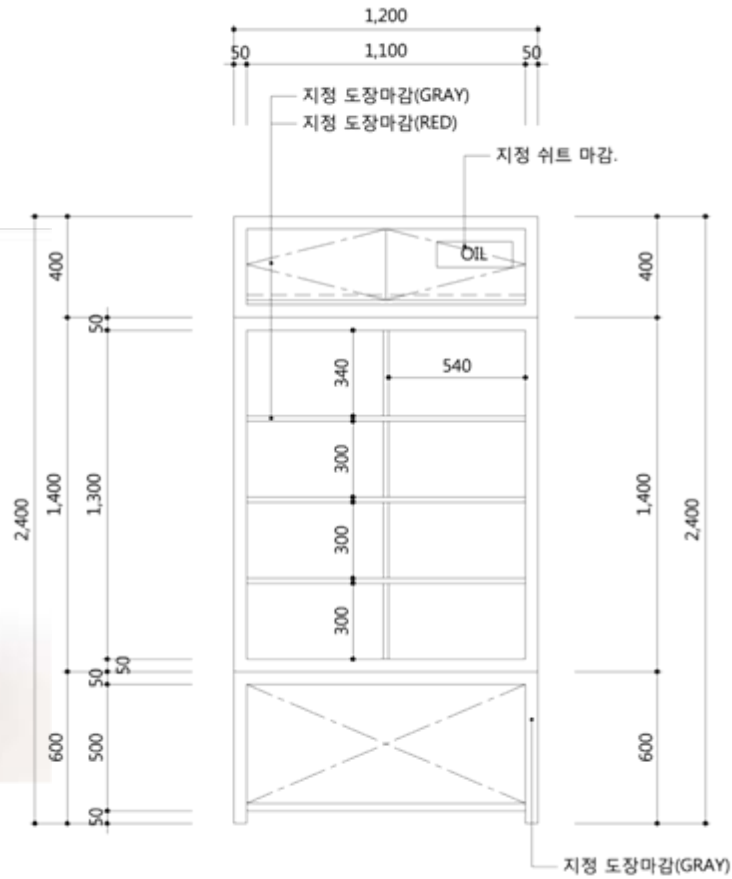

OIL
SCALE 1/20

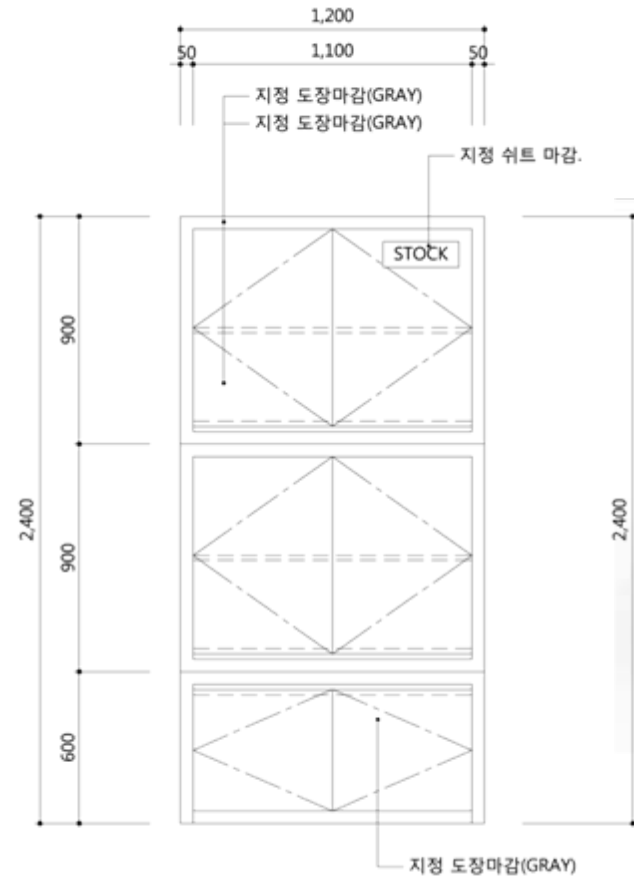

STOCK
SCALE 1/20



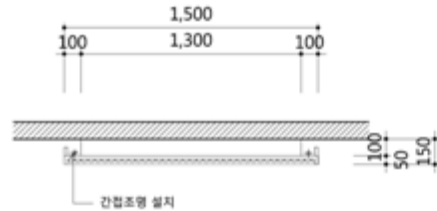

TOP VIEW SCALE 1/30

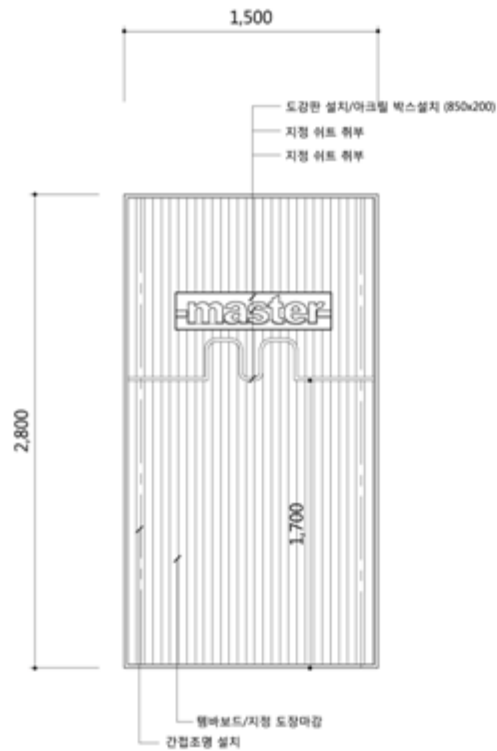

FRONT VIEW SCALE 1/30



PERSPECTIVE

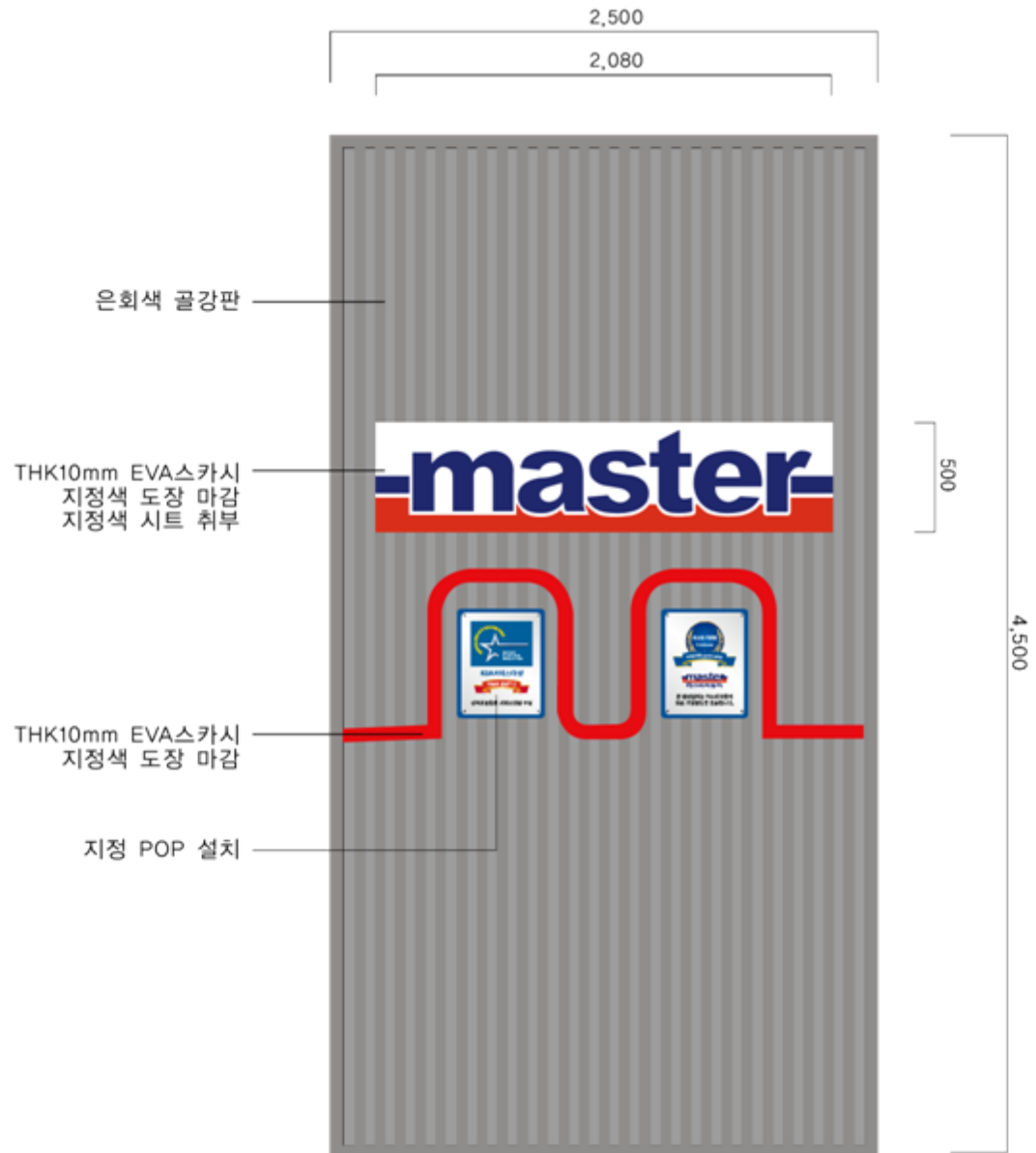

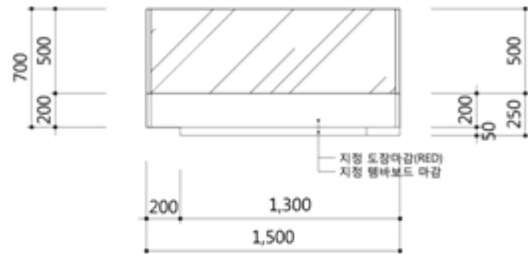

TOP VIEW

SCALE
1/30

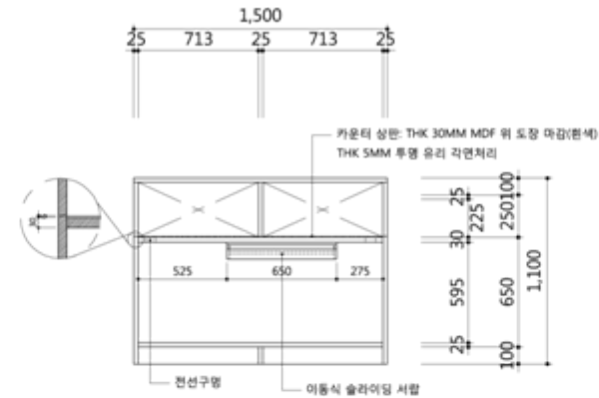

REAR VIEW

SCALE
1/30

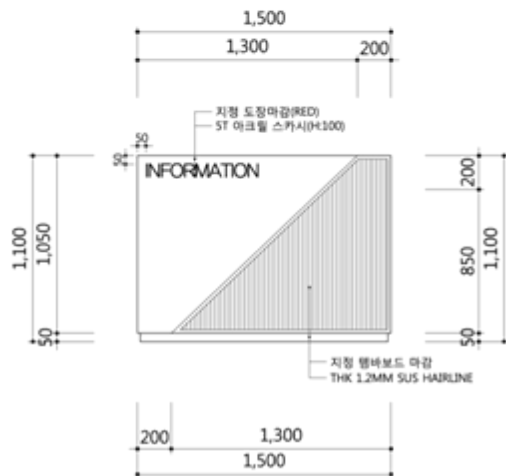

FRONT VIEW

SCALE
1/30

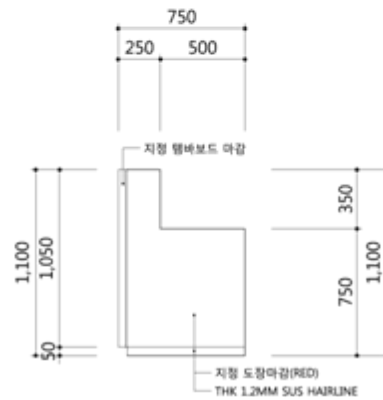

SIDE VIEW



PERSPECTIVE

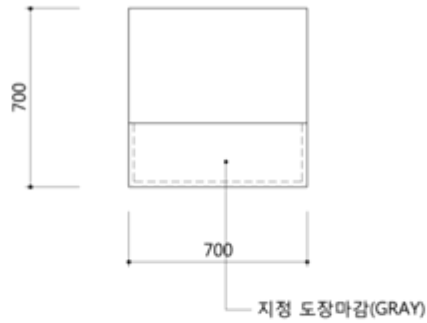

TOP VIEW

SCALE
1/20

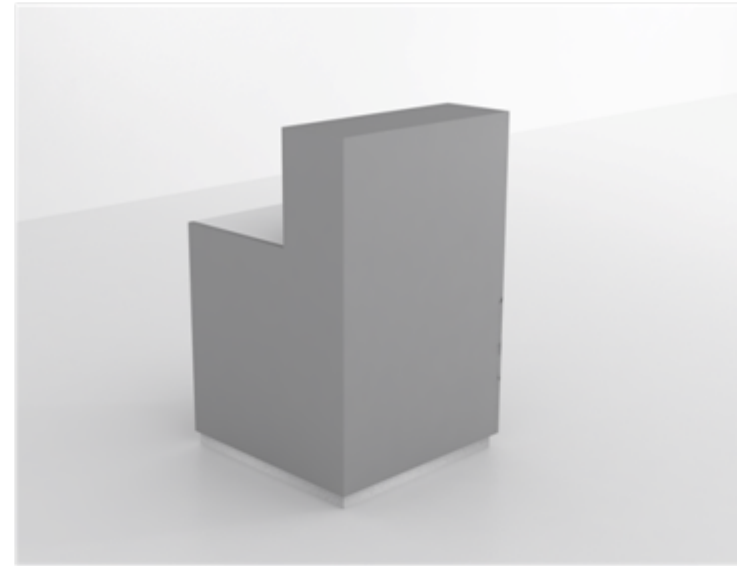

PERSPECTIVE

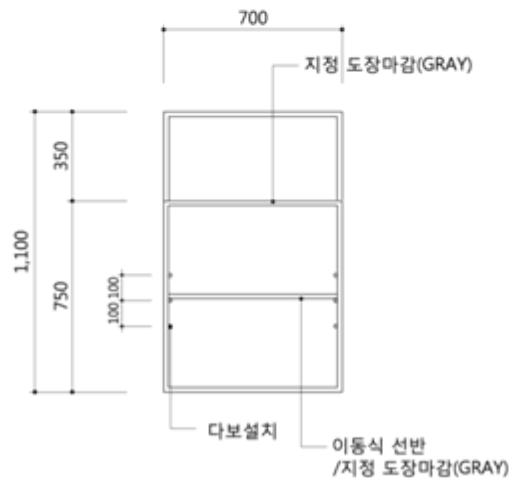

FRONT VIEW

SCALE
1/20

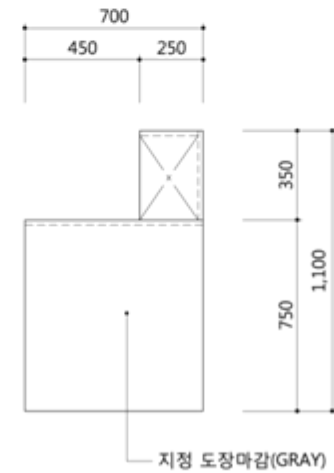

SIDE VIEW

SCALE
1/20

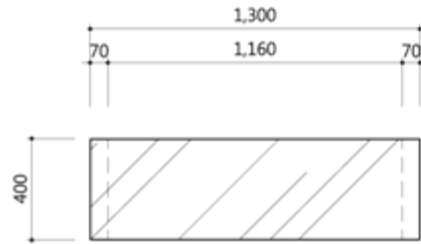

TOP VIEW

SCALE
1/20

PERSPECTIVE

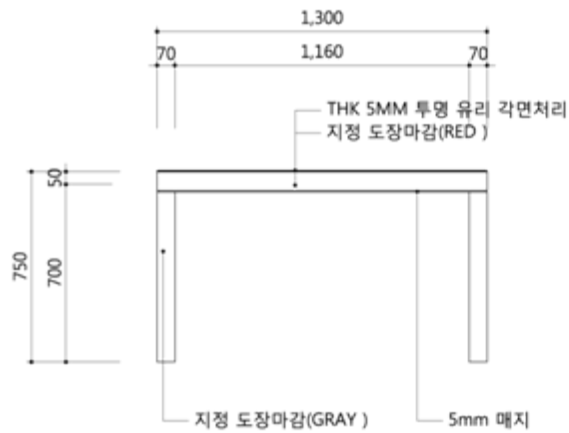

FRONT VIEW

SCALE
1/20

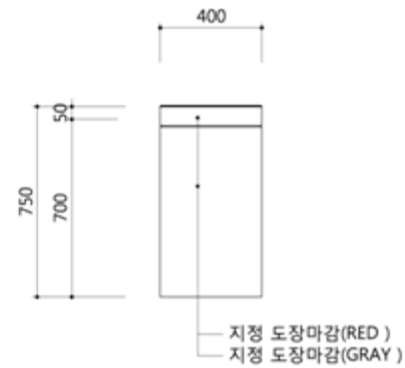

SIDE VIEW

SCALE
1/20

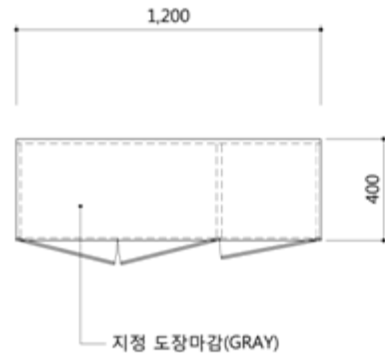

TOP VIEW

SCALE
1/20



PERSPECTIVE

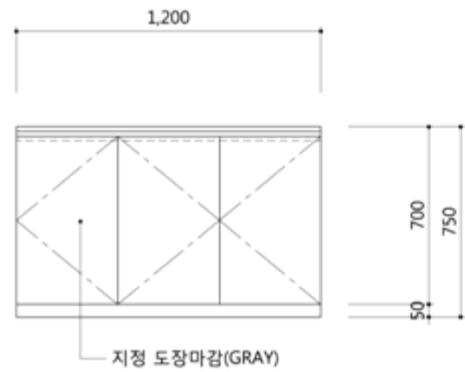

FRONT VIEW

SCALE
1/20

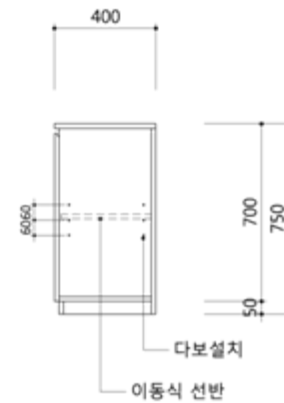

SIDE VIEW

SCALE
1/20

FURNITURE

기성가구(원형테이블+의자)



기성가구(원형테이블)
DS-T106









기성가구(테이블의자)
MUU-포니회의용(블루)



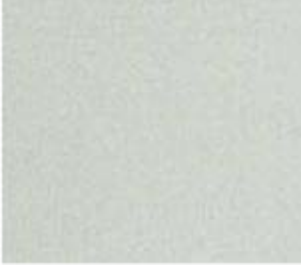

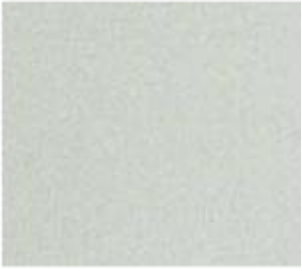
MATERIALS

작업장

Image	Spec	Image	Spec
	<ul style="list-style-type: none"> * Name : 고강도타일 * Size : 100X200 * Location: 작업장 바닥 		<ul style="list-style-type: none"> * Name : 에폭시 * Size : PANTONE 2758C * Location: 작업장 리프트라인
	<ul style="list-style-type: none"> * Name : 에폭시 라이닝 (PANTONE COOL GRAY 3) * Size : 3mm * Location : 작업장 바닥 		<ul style="list-style-type: none"> * Name : V.P 도장(PANTONE 423C) * Size : 현장치수 * Location: 작업장 천정
	<ul style="list-style-type: none"> * Name : 에폭시 코팅 (PANTONE COOL GRAY 3) * Size : 0.2mm * Location: 작업장 바닥 		<ul style="list-style-type: none"> * Name : V.P 도장(PANTONE 422C) * Size : 현장치수 * Location: 작업장 벽면



작업장

Image	Spec	Image	Spec
	<ul style="list-style-type: none"> * Name : 확산갓등/램프:메탈램프 * Size : 16인치(D:400) 250W (Black도장) "대현조명" * Location: 작업장 천정등 		
	<ul style="list-style-type: none"> * Name : 레이스웨이 * Size : 250W (Black) * Location: 작업장 천정등 		
	<ul style="list-style-type: none"> * Name : 와이어메쉬망 * Size : 공간(40X40) 3mm '엘앤제이파트너스' * Location: 작업장 천정 구조물 		



사무실

외부

Image	Spec	Image	Spec
	<ul style="list-style-type: none"> * Name : 폴리싱타일-6H011 * Size : 600X600(중국산) * Location: 사무실 바닥 		<ul style="list-style-type: none"> * Name : 52C 골강판 * Size : 현장치수 * Location: 외부골강 상부조명
	<ul style="list-style-type: none"> * Name : 스톤스트링 (그레이) * Size : Z:IN(현장사이즈) * Location: 사무실 벽면 		<ul style="list-style-type: none"> * Name : HQI * Size : 150W * Location: 외부골강 상부조명
	<ul style="list-style-type: none"> * Name : U-LAMP * Size : 6" PL * Location: 사무실천정 		